



# GOTESSENSONS

OFFICE CONFERENCE HOTEL 2018



FROM WORKPLACE  
TO CREATIVE SPACE™





FROM WORKPLACE

TO CREATIVE SPACE™

## SAY HELLO TO THIS YEAR'S NEWS!

One of the great news this year is that we welcome nine acoustic products from our affiliate company AM Acoustics, which will now be included in our product range. The same acoustic benefits and the same excellent quality, but under the Gotessons flag. This is positive for all, we assure you! We have tagged the products with the label "by AM Acoustics" to help you find the products in the catalogue and on the web. Also check out our new booth solution, *Peak Design Booth*, a screen with a slightly sloped shape to create dynamics and space in open landscapes. The popular *The Hut Collection* has again extended its range of products with several creative solutions for the activity-based plan. Plants are needed to create beautiful green oases; our new artificial plant *Bamboo* is also perfect as a room divider.







PILATES BALL – OFFICE BALLZ

BEAN BAG – OFFICE NAP



ERGO MAT – YOGA



PURE AIR ZONE – SOFA



# FEEL GOOD AT WORK

## AND INCREASE YOUR PRODUCTIVITY!

With today's progress in the office environment, we are looking for more open landscapes and activity-based work areas. This means a new creative way of working, but it can also mean workplace health risks.

**Sound;** when more people share the same areas and fewer own offices the noise level increases significantly. With today's architecture that involves a lot of metal, glass and other hard surfaces the sound reflection around and degrades the work environment. When entering the office of tomorrow, it's extra important to think about the acoustics, wall and ceiling sound absorbing products and on interior design products such as screens, carpets and curtains

*Read more about acoustic products on page 66-81.*

**Light;** having good and different types of lighting in the workplace is a must. It is important to have good general lighting and that some of the lighting can be directed to avoid reflections and also that brightness can be adjusted individually.

*Read more about The Lightning on page 106.*

**Air;** here we struggle with the same problems as with sound, more people in the same spaces, breathing the same air. Indoor air has been for some time worsened due to air pollution, limited ventilation, energy savings. At the same time several major scientific studies show that people will be both healthier and more productive of working in clean air.

*Read more about PAZ products on page 24 and 93.*

**Wellbeing;** ergonomically, it's best to change your way of working several times a day. Standing up or sitting on a pilates ball at the desk is proven better for health and promotes the right body posture. To change workplace and position is a way of preventing workplace related injuries. Stand up and walk around when you talk on the phone, invite to so-called "Walk and talk meetings" or why not stop and do some easy workout and exercise at the desk?

*Read more about Office Ballz on page 86.*

*Remember to drink a lot of water and when the noise gets too high, why not put on headphones and listen to relaxing music (or heavy metal!).*



# GOTESSENS 2018

INDEX	Desk Screens	12-29
	Toolbars, Rails, Accessories	30-39
	Floor Screens	40-59
	Whiteboard/Memoboard	60-65
	Wall- and Ceiling acoustics	66-81
	Showroom	82-83
	Soft Seating	84-93
	Ergonomic Products, Floor protection	94-99
	Plants	100-103
	Lightning	104-111
	Monitor Arms	112-119
	CPU holders, Cable holders, Cable collectors, Recycling	120-133
	Build your own product/Own Design	134-135
	Electrical Accessories	136-147
	From the beginning	148-149
	Product Registry, Information	150-151



EXPRESS ORDER

Choose express order and get your desk screens\* produced in 10 working days

\*Applies when ordering ScreenIT Standard and ScreenIT A30 in textile Event Screen, Cara and Synergy in selected colors, four selected zips or any seam. Maximum 100 screens/order in standard Catalogue version. Placed order can not be changed or cancelled. Mark the order with "Express Order".

EVENT SCREEN

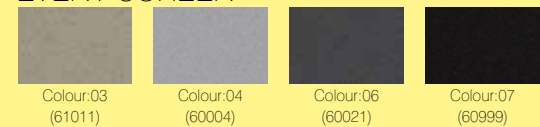

CARA



SYNERGY

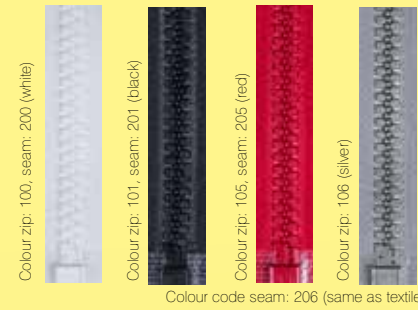

TEXTILE

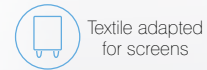

TEXTILE

NOBLE LUX BY TYGGROSSISTEN (Suede imitation textile, dirt repellent)

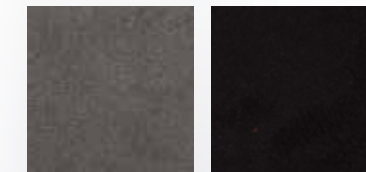

RADIO BY FIDIVI

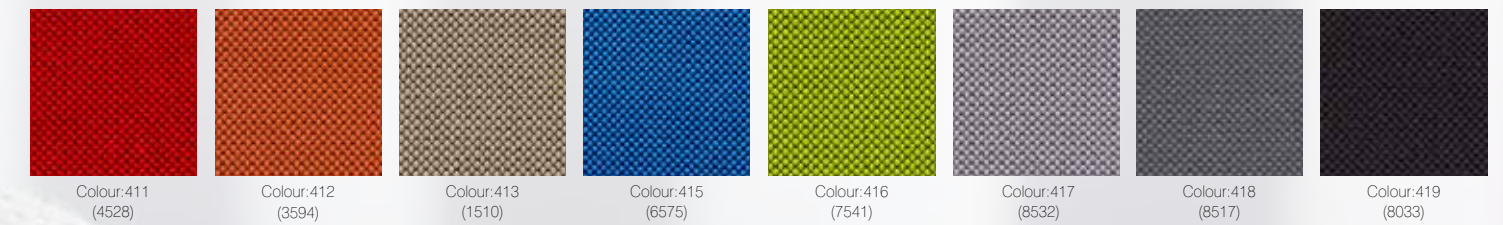

HOUSTON REFLECT BY NEVOTEX



CARA BY CAMIRA

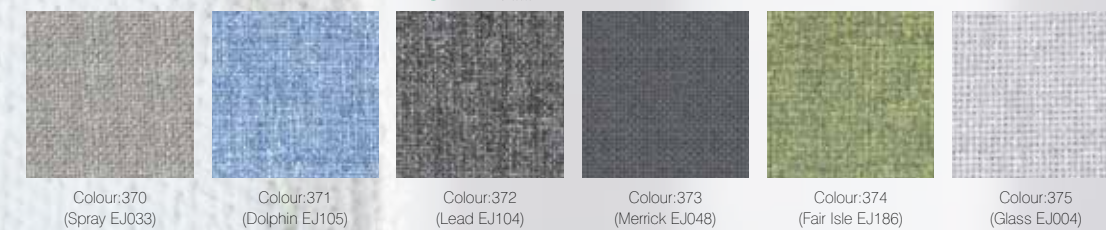

ARTIFICIAL LEATHER BY TYGGROSSISTEN

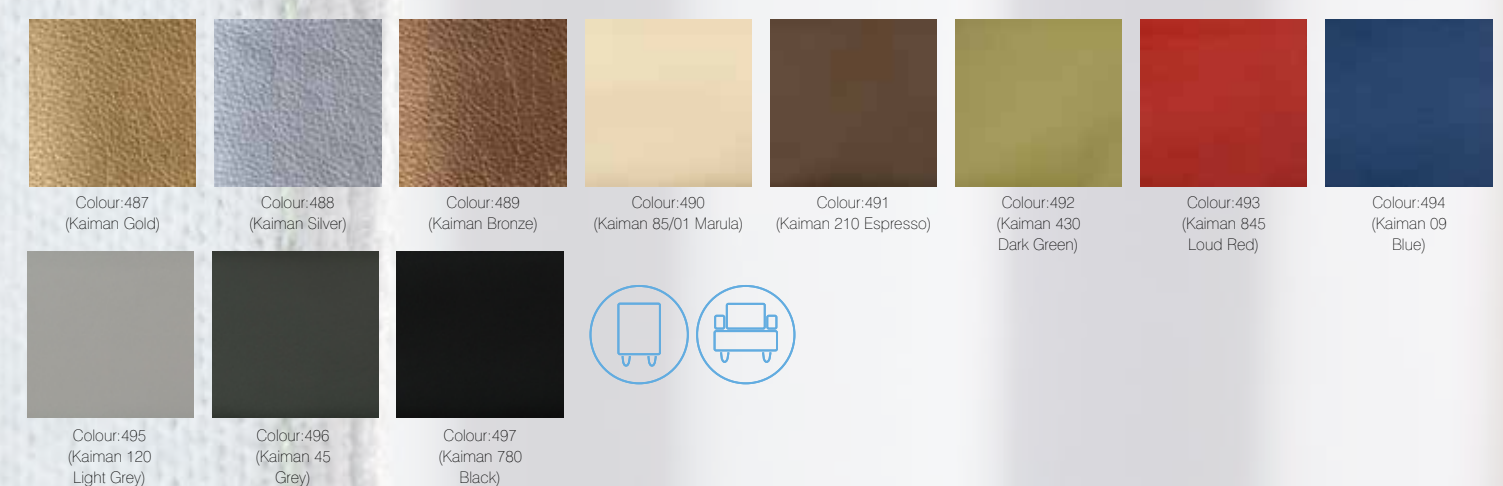

PRICE RANGE 1

EVENT SCREEN BY GABRIEL

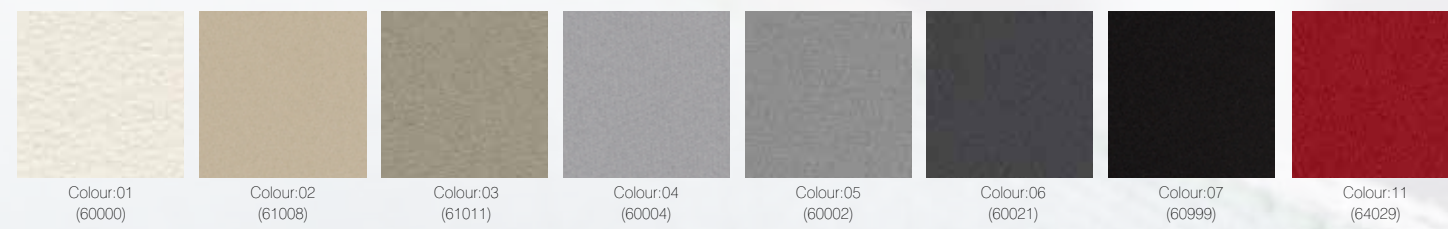

XPRESS BY GABRIEL

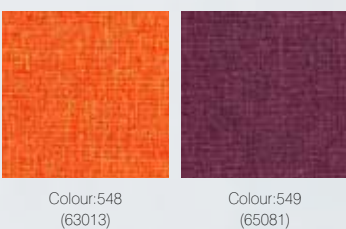

HUSH BY GABRIEL

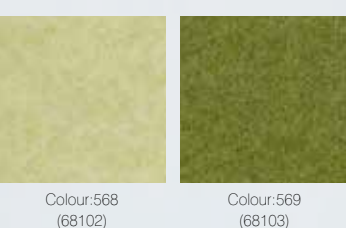



TEXTILE

PRICE RANGE 2

TWIST BY GABRIEL

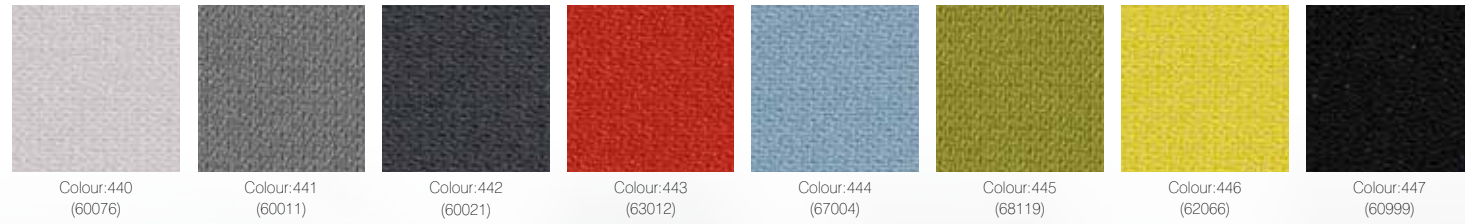

TWIST MELANGE BY GABRIEL

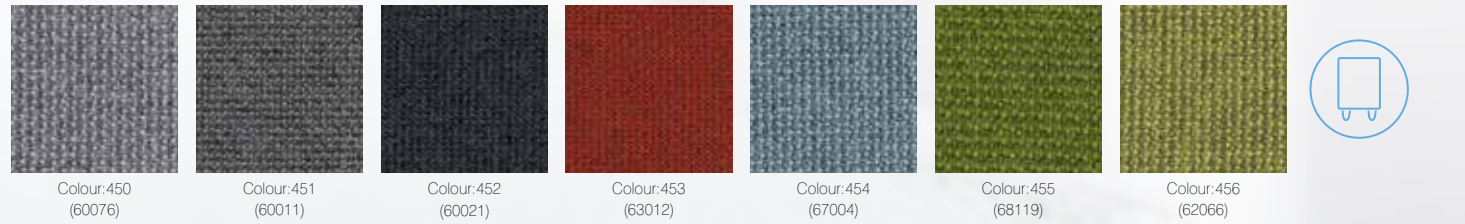

GOTESSONS BY BOGESUNDS



PRICE RANGE 3

SYNERGY BY CAMIRA

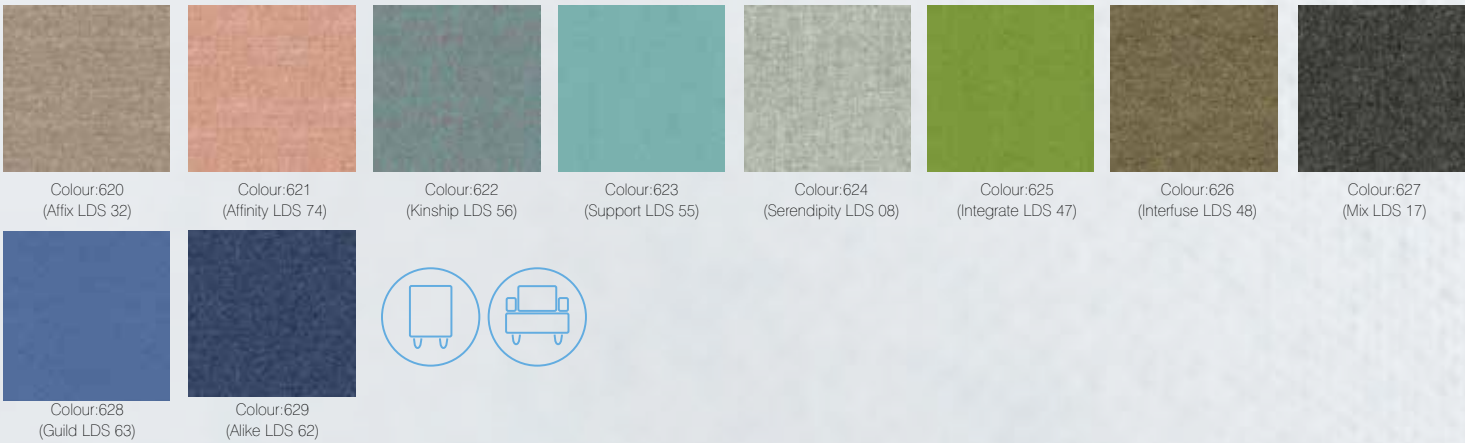

BLAZER BY CAMIRA



TEXTILE

PRICE RANGE 4

REMIX 2 BY KVADRAT



NOTE! For exact textile dyes, order textile maps from us.

ZIP

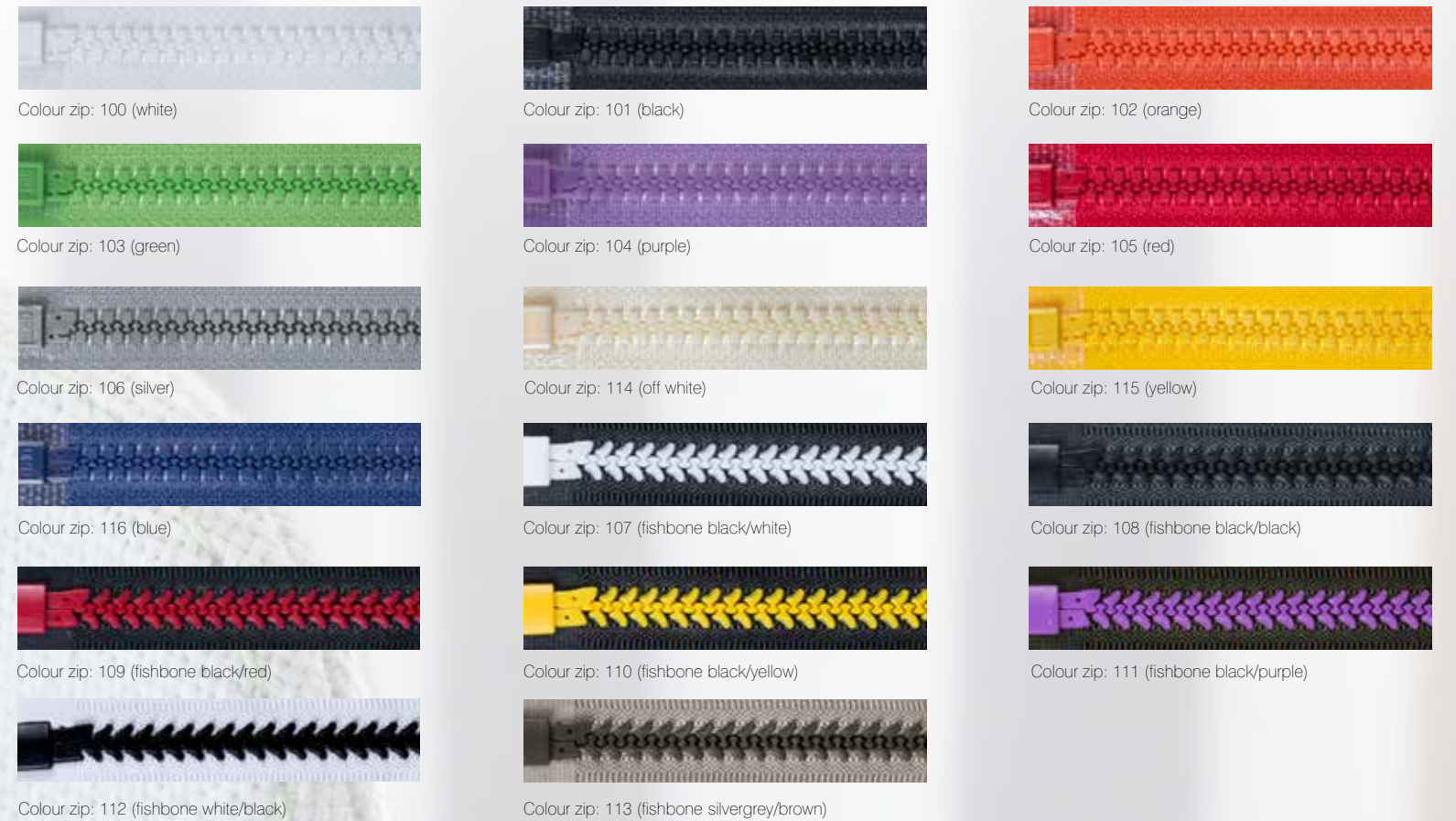

SEAM

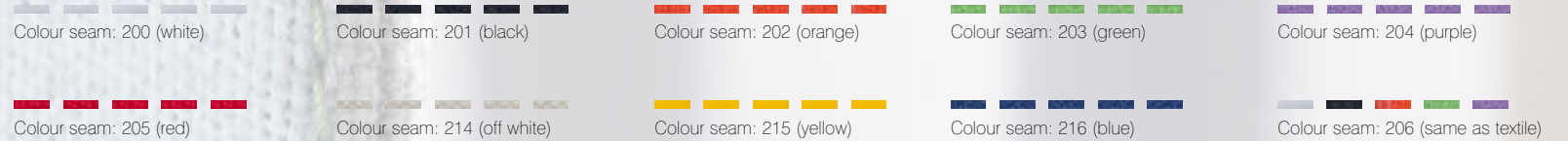

CORE MATERIAL

CORE MATERIAL ECOSUND "RAW"

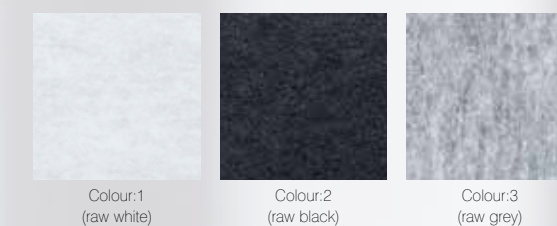
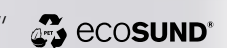

EcoSUND® is our unique core material for sound absorbents which is as good for people as it is for the environment. EcoSUND® is made of recycled PET and is approved in accordance with Öco-Tex Standard 100. **No emissions** EcoSUND® is completely free from glue/adhesives and does not emit any emissions or gases. **No harmful fibres** EcoSUND® does not release fibres that that itch, irritate or cause allergies.

FRAMES FOR COLLAGE, TELL-US AND STORYBOARD





# DESK AND FLOOR SCREENS

An easy way to create a personal space and privacy, even in the most open office landscape. ScreenIT desk and floor screens provide protection against noise while maintaining an open and transparent office. Their colour and shape contribute to a creative and productive environment.

The ScreenIT range has been expanded with several new screens.

## SCREENIT A30 Page 14-15

Wooden frame filled with sound absorbing anti-allergy foam and lined with foam laminated textile. Total thickness 40 mm. Tested and ISO A-classed by SP as floor and wall screens, tests results including fire class are available on our website. Max load 6 kg.

## SCREENIT A30 SLIDE Page 17

Slidable A30 screen mounted on a rail for horizontal movement. Ideal for workstations placed opposite each other.

## SCREENIT A30 FLEXIBLE Page 18

A30 multi-used screen with no holes.

## SCREENIT A30 REINFORCED Page 19

A wooden reinforced screen filled with A-classed sound absorbing material, pin able and with foam laminated textile. 40 mm thick. Takes up to 25 kg in accessories, monitors etc.

## SCREENIT A30 WITH BUILT IN RAIL Page 20

Reinforced A30 with a built in toolbar. Takes up to 25 kg in accessories, monitors etc.

## SCREENIT A30 ALL IN ONE Page 21

Like reinforced A30 but with a built-in (not on) toolbar rail with integrated cable channel inside the screen, exiting under the desk.

## SCREENIT A30 DESK BOOTH Page 22

A30 Screen and side screens zipped together.

## SCREENIT A30 WITH PLEXI Page 28

A30 with a plexi screen on the top. A perfect combination of sound absorption and visibility.

## SCREENIT A30 BOOTH Page 50

Floor screens zipped together to form a booth shape on discrete feet.

### PAZ (PURE AIR ZONE)

Table screen that enhances your productivity and health. PAZ combines the functions of sound absorption and air purification in a patented design. 54 mm thick. **Page 24-25**

### ECO LABELED SWAN CERTIFIED SCREENS

ScreenIT Standard  
ScreenIT A30  
ScreenIT A30 Reinforced  
ScreenIT A30 All In One  
ScreenIT A30 Desk Booth  
ScreenIT A30 Flexible  
ScreenIT A30 Floor Booth  
ScreenIT Slide  
ScreenIT AT40

### ECO LABELED SWAN CERTIFIED TEXTILES

Event Screen  
Cara  
Twist  
Twist Melange  
Blazer  
Synergy



### ORDER PROCEDURE SCREENS

1. SELECT SCREEN AND SCREEN SIZE

2. SELECT SCREEN COLOUR

See colour map at page 8-11.  
(Contact us for other textiles, colours and sizes.)

An extra cost of 55,24€ will be charged per change)

3. SELECT ZIP OR SEAM COLOUR

See colours on page 11.

4. SELECT CLAMPS OR MOUNTS

See page 32-33.

Specify the article number as follows:

Desk screen size - textile colour - zip/seam colour.

Example: 640160- 01- 101.

### ORDER PROCEDURE BOOTH

1. SELECT SCREEN AND SCREEN SIZE

2. SELECT SCREEN COLOUR

See colour map at page 8-11.  
(Contact us for other textiles, colours and sizes.)

An extra cost of 55,24€ will be charged per change)

3. SELECT SEAM COLOUR ON SCREEN

See colours on page 11.

4. SELECT ZIP TO CONNECT SCREENS

See page 11.

5. SELECT CLAMPS OR MOUNTS  
(ONLY DESK SCREEN)

See page 32-33.

Specify the article number as follows:

Screen booth - textile colour - seam colour - zip colour.

Example: 1178160 - 14 - 206 - 101

## SCREENIT STANDARD Page 16

The most competitive priced screen with a solid core and foam laminated textile. A-classed transmission effectiveness, meaning NO noise penetration. Total thickness 20 mm. Max load 6 kg.

## SCREENIT A40 Page 26

Material as A30 but with a thicker absorber. Total thickness 50 mm.

## SCREENIT AT40 Page 27

AT40 is made of a solid wood core with A-classed sound absorbing material on both sides. Total thickness 40 mm.

## SCREENIT PLEXI Page 29

Desk screen made of acrylic plastic (plexi). Available in frosted, smoked, transparent and print.

## THE RISING Page 44-45

A floor screen that you can raise and lower freely to the desired height.



# SCREENIT DESK SCREEN

The screen is developed to maximize sound absorption. It has a wooden frame filled with A-classed sound absorbing material and is coated with a foam laminated textile. It is also possible to use as pinboard. Max load 6 kg. For A30 Reinforced or All In One, see page 19+21.



## SCREENIT A30 P1 AND A30 K DESK SCREEN

P1 and A30 K has the same features as the A30, for details see above. The difference is the measurement from the outer edge to the bolt hole. A30 = 45 mm, A30 P1 = 150 mm and A30 K = 250 mm from the outer edge. Article numbers in column beside is for ScreenIT A30, if you want to order A30 P1 or A30 K, please contact Götesson's.



## SCREENIT A30

Art.No Size/Description  
(all dimensions in mm)

### SCREENIT A30 SOUND ABSORBING DESK SCREEN 650 MM

See price ranges on page 8-11.

Art.No	W.	H.
643080	800	650
643120	1200	650
643140	1400	650
643160	1600	650
643180	1800	650
643200	2000	650

Art.No	W.	H.
643080	800	650
643120	1200	650
643140	1400	650
643160	1600	650
643180	1800	650
643200	2000	650

### SCREENIT A30 SOUND ABSORBING DESK SCREEN 800 MM

Art.No	W.	H.
664080	800	800
664120	1200	800
664140	1400	800
664160	1600	800
664180	1800	800
664200	2000	800

Art.No	W.	H.
664080	800	800
664120	1200	800
664140	1400	800
664160	1600	800
664180	1800	800
664200	2000	800

#### Order procedure, see page 13.

Facts: 650 standard height from desk top 450 mm with clamp. With deskmount 430 mm if desk is 20 mm. 800 standard height from desk top 600 mm with clamp. With deskmount 580 mm if desk is 20 mm. Max load 6 kg.

Tip! You can see all accessories for screens and rails on page 34-39.

## SCREENIT A30 DESK SCREEN STRAIGHT CORNER

The screen is developed to maximize sound absorption. It has a wooden frame filled with A-classed sound absorbing material and is coated with a foam laminated textile. It is also possible to use as pinboard. Max load 6 kg.



## SCREENIT A30 STRAIGHT CORNER

Art.No Size/Description  
(all dimensions in mm)

### SCREENIT A30 SOUND ABSORBING DESK SCREEN 650 MM

See price ranges on page 8-11.

Art.No	W.	H.
543080	800	650
543120	1200	650
543140	1400	650
543160	1600	650
543180	1800	650
543200	2000	650

Art.No	W.	H.
543080	800	650
543120	1200	650
543140	1400	650
543160	1600	650
543180	1800	650
543200	2000	650

### SCREENIT A30 SOUND ABSORBING DESK SCREEN 800 MM

Art.No	W.	H.
564080	800	800
564120	1200	800
564140	1400	800
564160	1600	800
564180	1800	800
564200	2000	800

Art.No	W.	H.
564080	800	800
564120	1200	800
564140	1400	800
564160	1600	800
564180	1800	800
564200	2000	800

#### Order procedure, see page 13.

Facts: 650 standard height from desk top 450 mm with clamp. With deskmount 430 mm if desk is 20 mm. 800 standard height from desk top 600 mm with clamp. With deskmount 580 mm if desk is 20 mm. Max load 6 kg.



**Clamp set for desk screen**  
For up to 42 mm desks, 2 pcs in one pack.  
641010-1 white -2 black -3 silver



**Clamp set for desk screen longer than 1800 mm**  
For up to 42 mm desks, 3 pcs in one pack.  
641056-1 white -2 black -3 silver



**Clamp set for desk screen**  
For up to 72 mm desks, 2 pcs in one pack.  
641025-1 white -2 black -3 silver

**Clamp set for desk screen longer than 1800 mm**  
For up to 72 mm desks, 3 pcs in one pack.  
641035-1 white -2 black -3 silver



**Desk mount set for desk screen**  
To be mounted with screws under the desk, 2 pcs in one pack.  
641020-1 white -2 black -3 silver

**Desk mount set for desk screen longer than 1800 mm**  
To be mounted with screws under the desk, 3 pcs in one pack.  
641057-1 white -2 black -3 silver



**Corner clamp set for A30 desk screen**  
For clamping side and frontal screens at 90°. For 42 mm desks.  
641050-1 white -2 black -3 silver

**Corner clamp set for A30 desk screen**  
For clamping side and frontal screens at 90°. For 72 mm desks.  
641045-1 white -2 black -3 silver



**Corner mount set for A30 desk screen**  
For mounting side and frontal screens at 90°.  
641058-1 white -2 black -3 silver



**Angle bracket for desk screen**  
Used for corner mounting to hold the shields together.  
642034-1 white -2 black -3 silver



**Desk mount set for Halfpipe with keyhole**  
To be mounted with screws under the desk, 2 pcs in one pack.  
642065-1 white -3 silver



**Cable holder Halfpipe adjustable with keyhole for desk screen**  
770100 L.1000-1800 W.170 D.80 silver  
770100-1 L.1000-1800 W.170 D.80 white

**Cable holder Halfpipe adjustable for desk screen**  
760100 L.1000-1800 W.170 D.80 silver  
760100-1 L.1000-1800 W.170 D.80 white  
760100-8 L.1000-1800 W.170 D.80 black

**Halfpipe plastic end**  
740020 silver -1 white -2 black





## SCREENIT STANDARD

ScreenIT Standard comes at a very affordable price. Combine textile, zip or seam as desired. The screen has a solid core covered by a foam laminated textile for sound absorption. It is also possible to use as pinboard or mount a toolbar for accessories. Maximum load 6 kg.

Tip!

Mount the cable holder Halfpipe on the screen.



## SCREENIT STANDARD

Art.No Size/Description  
(all dimensions in mm)

### SCREENIT STANDARD 650 MM *See price ranges on page 8-11.*

#### Desk screen with seam

640080	W. 800	H. 650
640120	W. 1200	H. 650
640140	W. 1400	H. 650
640160	W. 1600	H. 650
640180	W. 1800	H. 650
640200	W. 2000	H. 650

#### Desk screen with zip

640080	W. 800	H. 650
640120	W. 1200	H. 650
640140	W. 1400	H. 650
640160	W. 1600	H. 650
640180	W. 1800	H. 650
640200	W. 2000	H. 650

### SCREENIT STANDARD 800 MM

#### Desk screen with seam

663080	W. 800	H. 800
663120	W. 1200	H. 800
663140	W. 1400	H. 800
663160	W. 1600	H. 800
663180	W. 1800	H. 800
663200	W. 2000	H. 800

#### Desk screen with zip

663080	W. 800	H. 800
663120	W. 1200	H. 800
663140	W. 1400	H. 800
663160	W. 1600	H. 800
663180	W. 1800	H. 800
663200	W. 2000	H. 800

#### Order procedure, see page 13.

Facts: 650 standard height from desk top 450 mm with clamp. With deskmount 430 mm if desk is 20 mm. 800 standard height from desk top 600 mm with clamp. With deskmount 580 mm if desk is 20 mm. Max load 6 kg.

#### Clamp set for desk screen

For up to 42 mm desks, 2 pcs in one pack.

641010-1 white -2 black -3 silver

#### Clamp set for desk screen longer than 1800 mm

For up to 42 mm desks, 3 pcs in one pack.

641056-1 white -2 black -3 silver

#### Clamp set for desk screen

For up to 72 mm desks, 2 pcs in one pack.

641025-1 white -2 black -3 silver

#### Clamp set for desk screen longer than 1800 mm

For up to 72 mm desks, 3 pcs in one pack.

641035-1 white -2 black -3 silver

#### Desk mount set for desk screen

To be mounted with screws under the desk, 2 pcs in one pack.

641020-1 white -2 black -3 silver

#### Desk mount set for desk screen longer than 1800 mm

To be mounted with screws under the desk, 3 pcs in one pack.

641057-1 white -2 black -3 silver

#### Angle bracket for desk screen

Used for corner mounting to hold the shields together.

642034-1 white -2 black -3 silver

#### Desk mount set for Halfpipe with keyhole

To be mounted with screws under the desk, 2 pcs in one pack.

642065-1 white -3 silver

#### Cable holder Halfpipe adjustable with keyhole for desk screen

770100 L.1000-1800 W.170 D.80 silver

770100-1 L.1000-1800 W.170 D.80 white

#### Cable holder Halfpipe adjustable for desk screen

760100 L.1000-1800 W.170 D.80 silver

760100-1 L.1000-1800 W.170 D.80 white

760100-8 L.1000-1800 W.170 D.80 black

#### Halfpipe plastic end

740020 silver -1 white -2 black

#### Adjustable height screen mount set

Height adjustable 280 mm. To be ordered with mount or clamp. 2 pcs in one pack.

641059-3 silver

#### Adjustable height screen mount set longer than 1800 mm

Height adjustable 280 mm. To be ordered with mount or clamp. 3 pcs in one pack.

641060-3 silver

Tip! You can see all accessories for screens and rails on page 34-39.



## SCREENIT A30 SLIDE

Horizontal slidable screen mounted on a rail under the desk. Ideal for workstations placed opposite each other.



## SCREENIT A30 SLIDE

Art.No Size/Description  
(all dimensions in mm)

### SCREENIT A30 SLIDE 650 MM *See price ranges on page 8-11.*

#### A30 Slide with seam

667080	W. 800	H. 650
667100	W. 1000	H. 650
667120	W. 1200	H. 650
667140	W. 1400	H. 650

#### A30 Slide with zip

667080	W. 800	H. 650
667100	W. 1000	H. 650
667120	W. 1200	H. 650
667140	W. 1400	H. 650

### SCREENIT A30 SLIDE 800 MM

#### A30 Slide with seam

1067080	W. 800	H. 800
1067100	W. 1000	H. 800
1067120	W. 1200	H. 800
1067140	W. 1400	H. 800

#### A30 Slide with zip

1067080	W. 800	H. 800
1067100	W. 1000	H. 800
1067120	W. 1200	H. 800
1067140	W. 1400	H. 800

#### Order procedure, see page 13.

Facts: Standard height from desk top if desk is 20 mm. 650 mm screen = 420 mm, 800 mm screen = 570 mm.

#### Slide rail for A30 Slide

Extruded aluminium slide rail pack. 1 rail/screen.

668140-1	1400 mm	white
668140-3	1400 mm	silver
668160-1	1600 mm	white
668160-3	1600 mm	silver
668180-1	1800 mm	white
668180-3	1800 mm	silver
668200-1	2000 mm	white
668200-3	2000 mm	silver

#### Slide rail for A30 Slide for Halfpipe with keyhole

Extruded aluminium slide rail pack. 1 rail/screen.

858140-1	1400 mm	white
858140-3	1400 mm	silver
858160-1	1600 mm	white
858160-3	1600 mm	silver
858180-1	1800 mm	white
858180-3	1800 mm	silver

#### Cable holder Halfpipe adjustable with keyhole for desk screen

770100 L.1000-1800 W.170 D.80 silver

770100-1 L.1000-1800 W.170 D.80 white



## HALFPIPE PACKAGE WITH KEYHOLE

For quick and easy mounting of the Halfpipe. Select rail package with key holes mount and adjustable Halfpipe keyhole. Can also be mounted directly on any ScreenIT range with mount 642065. See page 16.





Tip!  
ScreenIT A30  
with height adjustable  
mounting brackets.



## SCREENIT A30 FLEXIBLE

The screen can be used as a desk, floor and wall screen. This screen is without holes and can be ordered with height adjustable mounting brackets. The screen can then easily be moved up and down with an Allen key. See video on [www.gotessons.com](http://www.gotessons.com).



## SCREENIT A30 FLEXIBLE

Art.No Size/Description  
(all dimensions in mm)

### SCREENIT A30 FLEXIBLE 650 MM, ZIPPER ON LONG SIDE

See price ranges on page 8-11.

A30 no holes with seam		
627080	W. 800	H. 650
627120	W. 1200	H. 650
627140	W. 1400	H. 650
627160	W. 1600	H. 650
627180	W. 1800	H. 650
627200	W. 2000	H. 650
A30 no holes with zip		
627080	W. 800	H. 650
627120	W. 1200	H. 650
627140	W. 1400	H. 650
627160	W. 1600	H. 650
627180	W. 1800	H. 650
627200	W. 2000	H. 650

### SCREENIT A30 FLEXIBLE 800 MM, ZIPPER ON LONG SIDE

A30 no holes with seam		
625080	W. 800	H. 800
625120	W. 1200	H. 800
625140	W. 1400	H. 800
625160	W. 1600	H. 800
625180	W. 1800	H. 800
625200	W. 2000	H. 800
A30 no holes with zip		
625080	W. 800	H. 800
625120	W. 1200	H. 800
625140	W. 1400	H. 800
625160	W. 1600	H. 800
625180	W. 1800	H. 800
625200	W. 2000	H. 800

### SCREENIT A30 FLEXIBLE 650 MM, ZIPPER ON SHORT SIDE

See price ranges on page 8-11.

A30 no holes with seam		
623080	W. 650	H. 800
623120	W. 650	H. 1200
623140	W. 650	H. 1400
623160	W. 650	H. 1600
623180	W. 650	H. 1800
623200	W. 650	H. 2000
A30 no holes with zip		
623080	W. 650	H. 800
623120	W. 650	H. 1200
623140	W. 650	H. 1400
623160	W. 650	H. 1600
623180	W. 650	H. 1800
623200	W. 650	H. 2000

### SCREENIT A30 FLEXIBLE 800 MM, ZIPPER ON SHORT SIDE

A30 no holes with seam		
624080	W. 800	H. 800
624120	W. 800	H. 1200
624140	W. 800	H. 1400
624160	W. 800	H. 1600
624180	W. 800	H. 1800
624200	W. 800	H. 2000
A30 no holes with zip		
624080	W. 800	H. 800
624120	W. 800	H. 1200
624140	W. 800	H. 1400
624160	W. 800	H. 1600
624180	W. 800	H. 1800
624200	W. 800	H. 2000

### Order procedure, see page 13.

Facts: Standard height from desk top if desk is 20 mm.  
650 mm screen = 450 mm, 800 mm screen = 600 mm.

**Foot set Slide-in**  
2 pcs in one pack. L. 505 H. 200  
641075-1 white -2 black -3 silver

**Desk mount set Slide-in**  
2 pcs in one pack.  
641085-1 white -2 black -3 silver

**Desk clamp adjustable for screens without holes**  
2 pcs in one pack.  
642032-1 white -2 black -3 silver

**Desk mount adjustable for screens without holes**  
2 pcs in one pack.  
642033-1 white -2 black -3 silver

**Desk mount adjustable extended for screens without holes**  
2 pcs in one pack.  
642043-1 white -2 black -3 silver

**Wall package**  
List for wall mount.  
641063 500 mm  
641064 1000 mm (for screens longer than 1800 mm)

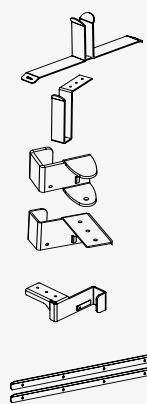

## SCREENIT A30 REINFORCED

The tremendously popular sound absorbing screen A30 is also available as a reinforced model that allows for weights of up to 25 kg. Ideal for hanging up tool arms and other accessories. Max load with desk mount 25 kg.

Tip!  
The toolbar creates a  
third level and space on  
the desk. See page 34.

## SCREENIT A30 P1 AND A30 K REINFORCED

A30 P1 and A30 K Reinforced has the same features as the A30 Reinforced, for details see above. The difference is the measurement from the outer edge to the bolt hole. A30= 45 mm, A30 P1= 150 mm and A30 K=250 mm from the outer edge. Article numbers in column beside is for ScreenIT A30, if you want to order A30 P1 or A30 K, please contact Gotessons.



## SCREENIT A30 REINFORCED

Art.No Size/Description  
(all dimensions in mm)

### SCREENIT A30 REINFORCED 650 MM

See price ranges on page 8-11.

A30 Reinforced with seam		
648080	W. 800	H. 650
648120	W. 1200	H. 650
648140	W. 1400	H. 650
648160	W. 1600	H. 650
648180	W. 1800	H. 650
648200	W. 2000	H. 650

A30 Reinforced with zip		
648080	W. 800	H. 650
648120	W. 1200	H. 650
648140	W. 1400	H. 650
648160	W. 1600	H. 650
648180	W. 1800	H. 650
648200	W. 2000	H. 650

### SCREENIT A30 REINFORCED 800 MM

A30 Reinforced with seam		
1049080	W. 800	H. 800
1049120	W. 1200	H. 800
1049140	W. 1400	H. 800
1049160	W. 1600	H. 800
1049180	W. 1800	H. 800
1049200	W. 2000	H. 800

A30 Reinforced with zip		
1049080	W. 800	H. 800
1049120	W. 1200	H. 800
1049140	W. 1400	H. 800
1049160	W. 1600	H. 800
1049180	W. 1800	H. 800
1049200	W. 2000	H. 800

### Order procedure, see page 13.

Facts: 650 standard height from desk top with deskmount 430 mm if desk is 20 mm. 800 standard height from desk top with deskmount 580 mm if desk is 20 mm.  
Max load 25 kg. Freewall not included. See page 34.

### For A30 Reinforced, use desk mount.

**Desk mount set for desk screen**  
To be mounted with screws under the desk, 2 pcs in one pack.  
641020-1 white -2 black -3 silver

**Desk mount set for desk screen longer than 1800 mm**  
To be mounted with screws under the desk, 3 pcs in one pack.  
641057-1 white -2 black -3 silver

**Angle bracket for desk screen**  
Used for corner mounting to hold the shields together.  
642034-1 white -2 black -3 silver

**Desk mount set for Halfpipe with keyhole**  
To be mounted with screws under the desk, 2 pcs in one pack.  
642065-1 white -3 silver

**Cable holder Halfpipe adjustable with keyhole for desk screen**  
770100 L.1000-1800 W.170 D.80 silver  
770100-1 L.1000-1800 W.170 D.80 white

**Cable holder Halfpipe adjustable for desk screen**  
760100 L.1000-1800 W.170 D.80 silver  
760100-1 L.1000-1800 W.170 D.80 white  
760100-8 L.1000-1800 W.170 D.80 black

**Halfpipe plastic end**  
740020 silver -1 white -2 black

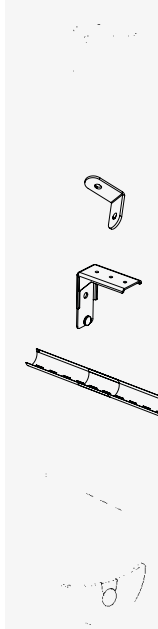

Tip! You can see all accessories for screens  
and rails on page 34-39.





## SCREENIT A30/A40 WITH BUILT IN RAIL

As ScreenIT A30/A40 but with a built in toolbar rail as opposed to as on page 41. A40 Reinforced, see page 26. Thickness: A30=40 mm. A40=50 mm. Can also be ordered with silver rail to the same price, to order start the article number with 10 instead of 11. Ex.1040080 instead of 1140080.



## SCREENIT A30 WITH BUILT IN RAIL

Art.No Size/Description  
(all dimensions in mm)

### SCREENIT A30 WITH BUILT IN RAIL 650 MM, WHITE

See price ranges on page 8-11.

A30 with seam			
1140080	W. 800	H. 650	
1140120	W. 1200	H. 650	
1140140	W. 1400	H. 650	
1140160	W. 1600	H. 650	
1140180	W. 1800	H. 650	
1140200	W. 2000	H. 650	

A30 with zip			
1140080	W. 800	H. 650	
1140120	W. 1200	H. 650	
1140140	W. 1400	H. 650	
1140160	W. 1600	H. 650	
1140180	W. 1800	H. 650	
1140200	W. 2000	H. 650	

### SCREENIT A30 WITH BUILT IN RAIL 800 MM WHITE

A30 with seam			
1170080	W. 800	H. 800	
1170120	W. 1200	H. 800	
1170140	W. 1400	H. 800	
1170160	W. 1600	H. 800	
1170180	W. 1800	H. 800	
1170200	W. 2000	H. 800	

A30 with zip			
1170080	W. 800	H. 800	
1170120	W. 1200	H. 800	
1170140	W. 1400	H. 800	
1170160	W. 1600	H. 800	
1170180	W. 1800	H. 800	
1170200	W. 2000	H. 800	

### SCREENIT A40 WITH BUILT IN RAIL 650 MM WHITE

A40 with seam			
1145080	W. 800	H. 650	
1145120	W. 1200	H. 650	
1145140	W. 1400	H. 650	
1145160	W. 1600	H. 650	
1145180	W. 1800	H. 650	
1145200	W. 2000	H. 650	

A40 with zip			
1145080	W. 800	H. 650	
1145120	W. 1200	H. 650	
1145140	W. 1400	H. 650	
1145160	W. 1600	H. 650	
1145180	W. 1800	H. 650	
1145200	W. 2000	H. 650	

### SCREENIT A40 WITH BUILT IN RAIL 800 MM, WHITE

A40 with seam			
1180080	W. 800	H. 800	
1180120	W. 1200	H. 800	
1180140	W. 1400	H. 800	
1180160	W. 1600	H. 800	
1180180	W. 1800	H. 800	
1180200	W. 2000	H. 800	

A40 with zip			
1180080	W. 800	H. 800	
1180120	W. 1200	H. 800	
1180140	W. 1400	H. 800	
1180160	W. 1600	H. 800	
1180180	W. 1800	H. 800	
1180200	W. 2000	H. 800	

### Order procedure, see page 13.

**Desk mount set for desk screen**  
To be mounted with screws under the desk, 2 pcs in one pack.  
641020-1 white -2 black -3 silver

**Desk mount set for desk screen longer than 1800 mm**  
To be mounted with screws under the desk, 3 pcs in one pack.  
641057-1 white -2 black -3 silver

**Angle bracket for desk screen**  
Used for corner mounting to hold the shields together.  
642034-1 white -2 black -3 silver

Tip! You can see all accessories for screens at page 36.



## SCREENIT A30 ALL IN ONE

ScreenIT A30 with built in Toolbar rail and integrated built in cable channel with exit under the desk. List available in silver only. See video at [www.gotessons.com](http://www.gotessons.com).

## SCREENIT A30 ALL IN ONE

Art.No Size/Description  
(all dimensions in mm)

### SCREENIT A30 ALL IN ONE

See price ranges on page 8-11.

A30 AIO with zip			
666120	W. 1200	H. 650	
666140	W. 1400	H. 650	
666160	W. 1600	H. 650	
666180	W. 1800	H. 650	
666200	W. 2000	H. 650	

### Order procedure, see page 13.

Facts: Standard height from desk top with desk mount 430 mm if desk is 20 mm. Max load with desk mount 25 kg.

Measurements inner cable channel: 60x30 mm.  
For A30 All In One, use desk mount.

**Desk mount set for desk screen**  
To be mounted with screws under the desk, 4 pcs in one pack.  
643050-1 white -2 black -3 silver

**Angle bracket for desk screen**  
Used for corner mounting to hold the shields together.  
642034-1 white -2 black -3 silver

**Desk mount set for Halfpipe with keyhole**  
To be mounted with screws under the desk, 4 pcs in one pack.  
643055-1 white -3 silver

**Cable holder Halfpipe adjustable with keyhole for desk screen**  
770100 L.1000-1800 W.170 D.80 silver  
770100-1 L.1000-1800 W.170 D.80 white

**Cable holder Halfpipe adjustable for desk screen**  
760100 L.1000-1800 W.170 D.80 silver  
760100-1 L.1000-1800 W.170 D.80 white  
760100-8 L.1000-1800 W.170 D.80 black

**Halfpipe plastic end**  
740020 silver -1 white -2 black







## SCREENIT A30 DESK BOOTH

Booth dividers connected with zipper. Side screens width is as standard 800 mm. Not available with fishbone zip. Contact us for other measurements.



## SCREENIT A30 ABOVE DESK

Screen mounted on the desk. Can be installed with clamp or with pins above or through the desk. Can also be placed on the desk.

## A30 BOOTH/SIDESCREEN/ABOVE DESK

Art.No Size/Description  
(all dimensions in mm)

### SCREENIT A30 DESK BOOTH 650 MM

See price ranges on page 8-11.

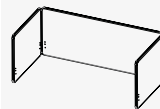

#### Booth desk

855120 W. 1200 H. 650  
855140 W. 1400 H. 650  
855160 W. 1600 H. 650  
855180 W. 1800 H. 650

### SCREENIT A30 DESK BOOTH 800 MM

#### Booth desk

1181120 W. 1200 H. 800  
1181140 W. 1400 H. 800  
1181160 W. 1600 H. 800  
1181180 W. 1800 H. 800

### Order procedure, see page 13.

Facts: 650 standard height from desk top 450 mm with clamp. With deskmount 430 mm if desk is 20 mm. 800 standard height from desk top 600 mm with clamp. With deskmount 580 mm if desk is 20 mm. Max load 6 kg.

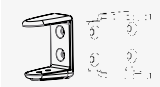

#### Clamp set for booth, package

For up to 42 mm desks. 6 clamps includes. 2 clamps and 4 corner clamps.

641068-1 white -2 black -3 silver

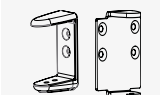

#### Clamp set for booth, package

For up to 72 mm desks. 6 clamps includes. 2 clamps and 4 corner clamps.

641071-1 white -2 black -3 silver



#### Desk mount for desk booth, package

To be mounted with screws under the desk. 2 desk mount and 4 corner desk mount.

641069-1 white -2 black -3 silver

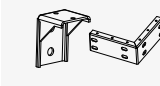

#### Desk mount Mini to the desk booth, package

Assembled with screws under the desk. Four brackets are included. 2 Mini desk mounts and 2 Slim corner mounts.

642027-1 white -2 black -3 silver



#### Cable holder Halfpipe adjustable for desk screen

760100 L.1000-1800 W.170 D.80 silver  
760100-1 L.1000-1800 W.170 D.80 white  
760100-8 L.1000-1800 W.170 D.80 black



#### Halfpipe plastic end

740020 silver -1 white -2 black

### SCREENIT A30 ABOVE DESK

See price ranges on page 8-11.



#### A30 with seam

857076 W. 760 H. 450  
857080 W. 800 H. 450  
857120 W. 1200 H. 450  
857140 W. 1400 H. 450  
857160 W. 1600 H. 450  
857180 W. 1800 H. 450  
857200 W. 2000 H. 450

#### A30 with zip

857076 W. 760 H. 450  
857080 W. 800 H. 450  
857120 W. 1200 H. 450  
857140 W. 1400 H. 450  
857160 W. 1600 H. 450  
857180 W. 1800 H. 450  
857200 W. 2000 H. 450

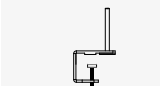

#### Desk clamp for A30 above desk

For up to 42 mm desks.  
Content: 2 desk clamp and 2 pins.  
642090-1 white -2 black -3 silver



#### Desk clamp Small for A30 above desk

For up to 42 mm desks.  
Content: 2 desk clamp and 2 pins.  
642088-1 white -2 black -3 silver

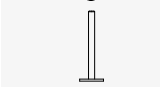

#### Pin for A30 above desk

Content: 2 pins.  
642095-1 white -2 black -3 silver

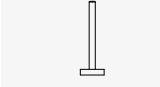

#### Pins for A30 above desk, completion

Content: 2 pins. for achieving the same height as front screen with clamps.  
642089-1 white -2 black -3 silver

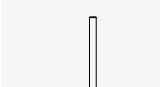

#### Foot for A30 above desk

Content: Two pins with circular foot, Ø105 mm. Standing on the desk. Felt pads included.  
642093-1 white -2 black -3 silver



## SCREENIT A30 SIDESCREEN

Desk screen for dividing workspace above desk. Height is adapted to be combined with a desk screen mounted with clamps.



## FOLDIT BASIC

Portable desk screen. Easy to fold and put away. Only available in this version.

## FOLDIT

Portable and foldable screens ideal for examinations, small workspaces and dividing large tables temporarily.



## SIDESCREEN/FOLDIT/FOLDIT BASIC

Art.No Size/Description  
(all dimensions in mm)

### SCREENIT A30 SIDESCREEN

See price ranges on page 8-11.



#### A30 Sidescreen with seam

760450 W. 760 H. 450  
800450 W. 800 H. 450

#### A30 Sidescreen with zip

760450 W. 760 H. 450  
800450 W. 800 H. 450



#### Desk clamp for ScreenIT A30 Sidescreen

For up to 42 mm desks. 1 clamp included, Adapted to a desk screen mounted with clamps.  
642068-1 white -2 black -3 silver

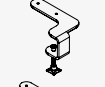

#### Desk clamp right for ScreenIT A30 Sidescreen

For up to 42 mm desks. 1 clamp included.  
642082-1 white -2 black -3 silver



#### Desk clamp left for ScreenIT A30 Sidescreen

For up to 42 mm desks. 1 clamp included.  
642083-1 white -2 black -3 silver



#### Desk clamp Small for ScreenIT A30 Sidescreen

For up to 27 mm desks. 1 clamp included, Adapted to a desk screen mounted with clamps.  
643011-1 white -2 black -3 silver



#### Desk clamp Small right for ScreenIT A30 Sidescreen

For up to 27 mm desks. 1 clamp included.  
643012-1 white -2 black -3 silver



#### Desk clamp Small left for ScreenIT A30 Sidescreen

For up to 27 mm desks. 1 clamp included.  
643013-1 white -2 black -3 silver

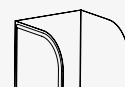

### FOLDIT BASIC

Molded material in EcoSUND dressed in black acoustic textile.

621300 W. 420 H. 420 D. 420  
621700 W. 820 H. 420 D. 420

Note! Only available in this version. Thickness 10 mm.



### FoldIT Basic hook

To hang FoldIT Basic on a wall.

642084-1 white

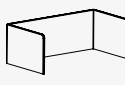

### FOLDIT

See price ranges on page 8-11.

#### FoldIT

629500 See below  
621160 See below  
621470 See below

Measure: 629500= W. 940 H. 410 D 520  
621160= W. 1140 H. 410 D 620  
621470= W. 1440 H. 410 D 720



### Linking bracket for FoldIT

To link screens together.

642072-2 black

### Order procedure, see page 13.

Note! Can only be ordered with seam. Outer measures specified. Thickness 20 mm.



# PAZ (PURE AIR ZONE) DESK SCREEN

A product that both increases your productivity and your health.

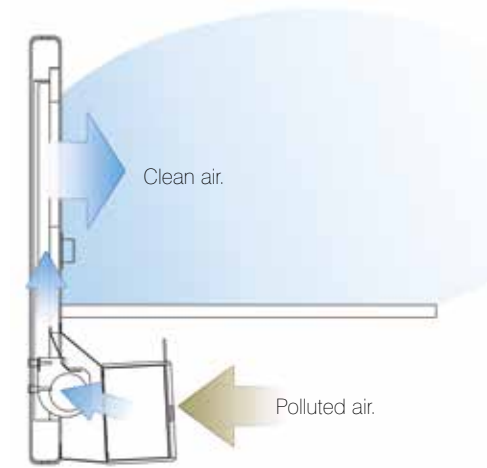

## PAZ

A unique desk screen that enhances your productivity and health. PAZ stands for Pure Air Zone. PAZ combines the functions of sound absorption and air purification in a patented design. Creates a bubble of clean air through the front of the screen. Draught-free. Mute. Energy-efficient. See the product film on Gotessons Youtube channel. Comes complete with filters and cable trench. Can only be ordered with Harlequin or Runner.

## HARLEQUIN



Colour:500 (64081 Red)    Colour:501 (63053 Orange)    Colour:502 (66118 Purple)    Colour:504 (61152 Dark grey)    Colour:505 (60999 Black)    Colour:506 (68095 Green)

## RUNNER

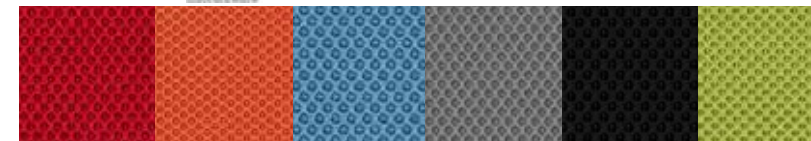

Colour:520 (64089 Red)    Colour:521 (63034 Orange)    Colour:522 (66063 Light blue)    Colour:523 (60011 Light grey)    Colour:525 (60999 Black)    Colour:526 (68056 Green)

## PAZ DESK SCREEN

Art.No    Size/Description  
(all dimensions in mm)

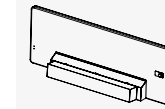

PAZ DESK SCREEN		
105120	W. 1200	H. 675
105140	W. 1400	H. 675
105160	W. 1600	H. 675
105180	W. 1800	H. 675

Facts: Standard height from desk top 425 mm if desk is 20 mm. Screen thickness 54 mm.

### ORDER PROCEDURE PAZ DESK SCREEN

Art.No - Colour textile- Colour Zip (see page 8-11)  
Example: 105160-522-107 = PAZ Desk screen 1600 with light blue Runner and fishbone zip.  
Don't forget to order desk mount.

### For PAZ, only with desk mount.

**Desk mount set for desk screen**  
To be mounted with screws under the desk, 2 pcs in one pack.  
641020-1 white -2 black -3 silver

### Replacement filter

Needs to be renewed every second year.  
105119

### TEQUINAL DATA:

Type of filter: Front filter+ Fine filter F9 (EN 779: 2012)  
Air Flow: LOW/MEDIUM/BOOST 40/50/240 m3/h ±10  
Equivalent Air Flow: LOW/MEDIUM/BOOST 38/47,5/228 m3/h ±10  
Noise Level: LOW/MEDIUM/BOOST 28/32/47 dB(A)  
Energy consumption LOW/MEDIUM/BOOST 25/31/68 W  
Weight: 21,5 kg (1600 x 675 mm)  
The fan builds 220 mm under desk.

For more information see [www.gotessons.com](http://www.gotessons.com).

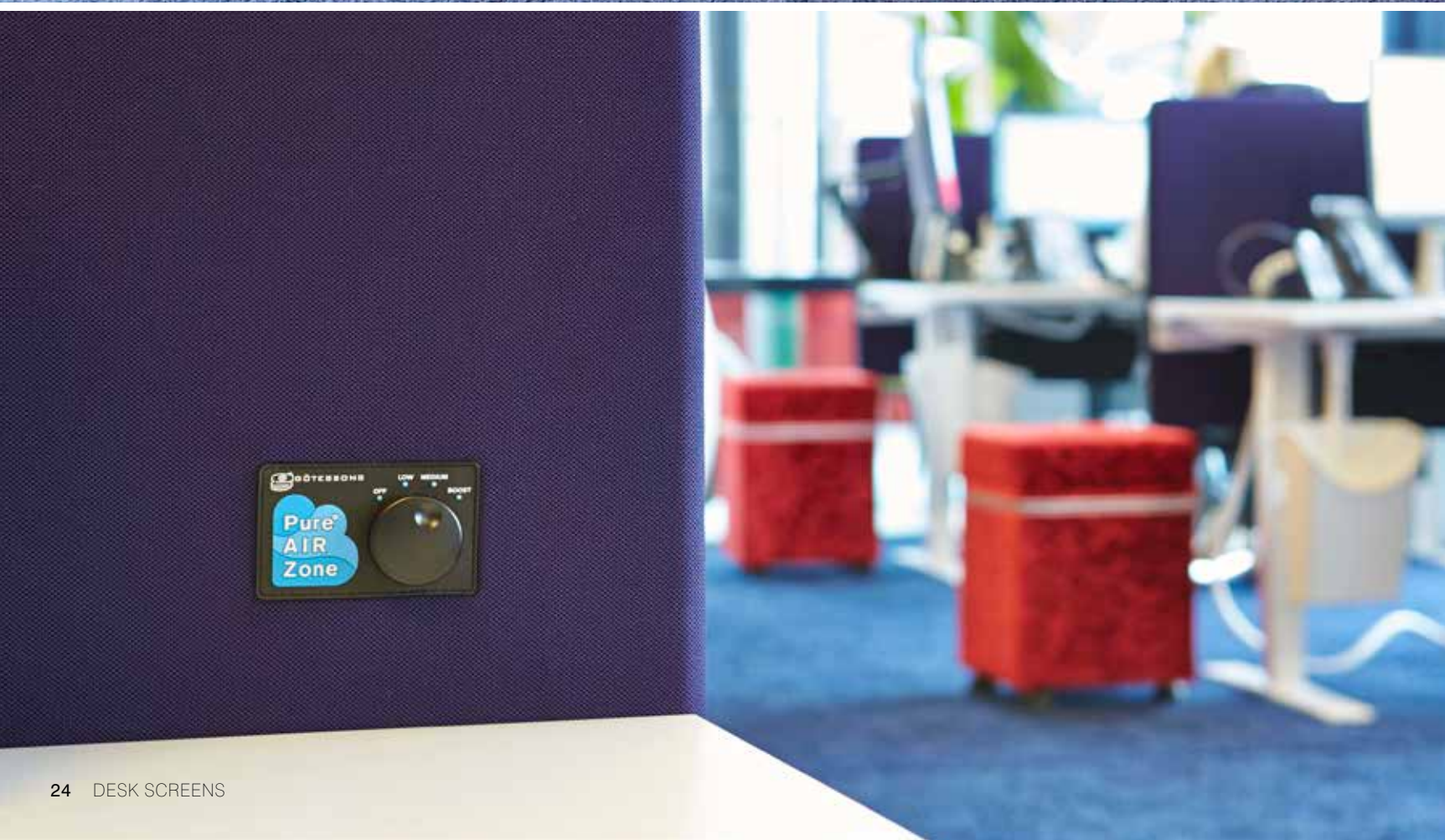





Tip!

Colour match screen and stool. See page 90.

## SCREENIT A40 DESK SCREEN

A40 is constructed with a wooden frame filled with 40 mm A-rated sound absorbing materials and foam laminated textile for a good sound absorption. Total thickness of the screen is 50 mm. Choose from a variety of textiles and combine with seam or zipper.



### A40 WITH STRAIGHT CORNERS

A40 is available with straighter design on the corners. Start the article number with 50 instead of 10 when ordering. Ex. 5043160 is a desk screen with width 1600 mm and straight corners. A40 Reinforced is not available with straight corners.

## SCREENIT A40/A40 REINFORCED

Art.No Size/Description  
(all dimensions in mm)

### SCREENIT A40 SOUND ABSORBING DESK SCREEN 650 MM

See price ranges on page 8-11.

A40 desk screen with seam			
1043080	W. 800	H. 650	
1043120	W. 1200	H. 650	
1043140	W. 1400	H. 650	
1043160	W. 1600	H. 650	
1043180	W. 1800	H. 650	
1043200	W. 2000	H. 650	

A40 desk screen with zip			
1043080	W. 800	H. 650	
1043120	W. 1200	H. 650	
1043140	W. 1400	H. 650	
1043160	W. 1600	H. 650	
1043180	W. 1800	H. 650	
1043200	W. 2000	H. 650	

### SCREENIT A40 SOUND ABSORBING DESK SCREEN 800 MM

A40 desk screen with seam			
1064080	W. 800	H. 800	
1064120	W. 1200	H. 800	
1064140	W. 1400	H. 800	
1064160	W. 1600	H. 800	
1064180	W. 1800	H. 800	
1064200	W. 2000	H. 800	

A40 desk screen with zip			
1064080	W. 800	H. 800	
1064120	W. 1200	H. 800	
1064140	W. 1400	H. 800	
1064160	W. 1600	H. 800	
1064180	W. 1800	H. 800	
1064200	W. 2000	H. 800	

Mounts not included.  
For mounts for ScreenIT A40 see page 14.

### SCREENIT A40 REINFORCED 650 MM

See price ranges on page 8-11.

A40 Reinforced with seam			
1048080	W. 800	H. 650	
1048120	W. 1200	H. 650	
1048140	W. 1400	H. 650	
1048160	W. 1600	H. 650	
1048180	W. 1800	H. 650	
1048200	W. 2000	H. 650	

A40 Reinforced with zip			
1048080	W. 800	H. 650	
1048120	W. 1200	H. 650	
1048140	W. 1400	H. 650	
1048160	W. 1600	H. 650	
1048180	W. 1800	H. 650	
1048200	W. 2000	H. 650	

### SCREENIT A40 REINFORCED 800 MM

A40 Reinforced with seam			
1068080	W. 800	H. 800	
1068120	W. 1200	H. 800	
1068140	W. 1400	H. 800	
1068160	W. 1600	H. 800	
1068180	W. 1800	H. 800	
1068200	W. 2000	H. 800	

A40 Reinforced with zip			
1068080	W. 800	H. 800	
1068120	W. 1200	H. 800	
1068140	W. 1400	H. 800	
1068160	W. 1600	H. 800	
1068180	W. 1800	H. 800	
1068200	W. 2000	H. 800	

Order procedure, see page 13.

Mounts not included.  
For mounts for ScreenIT A40 Reinforced see page 19.

Tip! You can see all accessories for screens and rails on page 34-39.



## SCREENIT AT40

AT40 has a solid core and on either side A-classed sound absorbing material covered by a foam laminated textile of choice. AT40 is also available with height 800 mm. Contact Gotessons for article number and price.



## SCREENIT AT40 DESK TOP

A smaller AT40 desk screen that is easy to place above desk with a special made desk mount. Also as dividing screens in bench systems, contact us or see [www.gotessons.com](http://www.gotessons.com).

## SCREENIT AT40/AT40 DESK TOP

Art.No Size/Description  
(all dimensions in mm)

### SCREENIT AT40

See price ranges on page 8-11.

AT40 with seam			
626080	W. 800	H. 650	
626120	W. 1200	H. 650	
626140	W. 1400	H. 650	
626160	W. 1600	H. 650	
626180	W. 1800	H. 650	
626200	W. 2000	H. 650	

AT40 with zip			
626080	W. 800	H. 650	
626120	W. 1200	H. 650	
626140	W. 1400	H. 650	
626160	W. 1600	H. 650	
626180	W. 1800	H. 650	
626200	W. 2000	H. 650	

Order procedure, see page 13.

Facts: Standard height from desk top 450 mm with clamp. With desk mount 430 mm if desk is 20 mm. Max load 6 kg.

#### Clamp set for desk screen

For up to 42 mm desks, 2 pcs in one pack.  
641010-1 white -2 black -3 silver

#### Clamp set for desk screen longer than 1800 mm

For up to 42 mm desks, 3 pcs in one pack.  
641056-1 white -2 black -3 silver

#### Clamp set for desk screen

For up to 72 mm desks, 2 pcs in one pack.  
641025-1 white -2 black -3 silver

#### Clamp set for desk screen longer than 1800 mm

For up to 72 mm desks, 3 pcs in one pack.  
641035-1 white -2 black -3 silver

#### Desk mount set for desk screen

To be mounted with screws under the desk, 2 pcs in one pack.  
641020-1 white -2 black -3 silver

#### Desk mount set for desk screen longer than 1800 mm

To be mounted with screws under the desk, 3 pcs in one pack.  
641057-1 white -2 black -3 silver

#### Angle bracket for desk screen

Used for corner mounting to hold the shields together.  
642034-1 white -2 black -3 silver

#### Desk mount set for Halfpipe with keyhole

To be mounted with screws under the desk, 2 pcs in one pack.  
642065-1 white -3 silver

#### Cable holder Halfpipe adjustable with keyhole for desk screen

770100 L.1000-1800 W.170 D.80 silver  
770100-1 L.1000-1800 W.170 D.80 white

#### Cable holder Halfpipe adjustable for desk screen

760100 L.1000-1800 W.170 D.80 silver  
760100-1 L.1000-1800 W.170 D.80 white  
760100-8 L.1000-1800 W.170 D.80 black

#### Halfpipe plastic end

740020 silver -1 white -2 black

### SCREENIT AT40 DESK TOP

See price ranges on page 8-11.

AT40 with seam			
621760	W. 760	H. 450	
626800	W. 800	H. 450	
621200	W. 1200	H. 450	
621400	W. 1400	H. 450	
621600	W. 1600	H. 450	
621800	W. 1800	H. 450	
622000	W. 2000	H. 450	

AT40 with zip			
621760	W. 760	H. 450	
626800	W. 800	H. 450	
621200	W. 1200	H. 450	
621400	W. 1400	H. 450	
621600	W. 1600	H. 450	
621800	W. 1800	H. 450	
622000	W. 2000	H. 450	

#### Clamp AT40 above desk

For up to 22 mm desks, 2 pcs in one pack.  
642050-1 white -2 black -3 silver

#### Clamp AT40 above desk longer than 1800 mm

For up to 22 mm desks, 3 pcs in one pack.  
642070-1 white -2 black -3 silver

#### Clamp AT40 above desk

For up to 50 mm desks, 2 pcs in one pack.  
642060-1 white -2 black -3 silver

#### Clamp AT40 above desk longer than 1800 mm

For up to 50 mm desks, 3 pcs in one pack.  
642080-1 white -2 black -3 silver



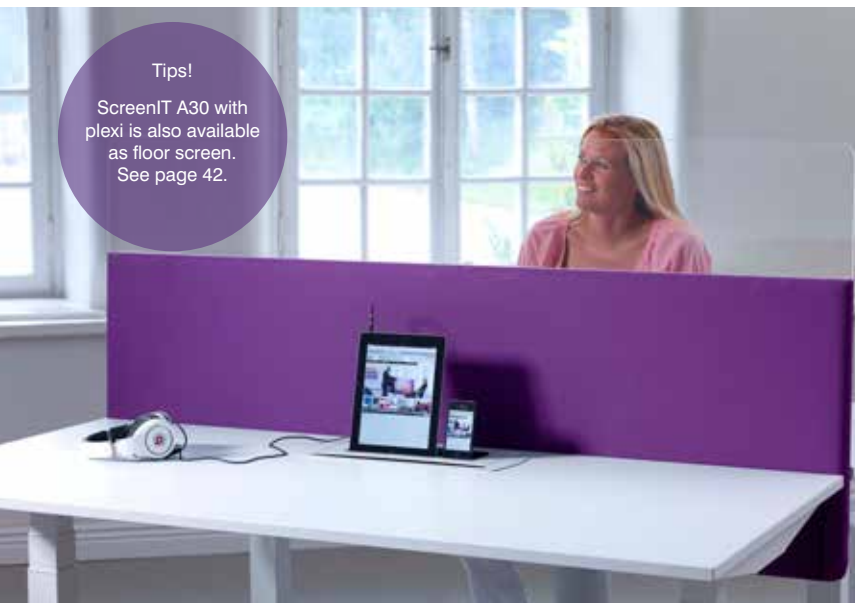

**Tips!**  
ScreenIT A30 with plexi is also available as floor screen. See page 42.

### SCREENIT A30 WITH TRANSPARENT PLEXI

A30 with a plexi screen top. Perfect when you want to be seen but not heard. (Can only be ordered with seam).



### SCREENIT A30 WITH FROSTED PLEXI

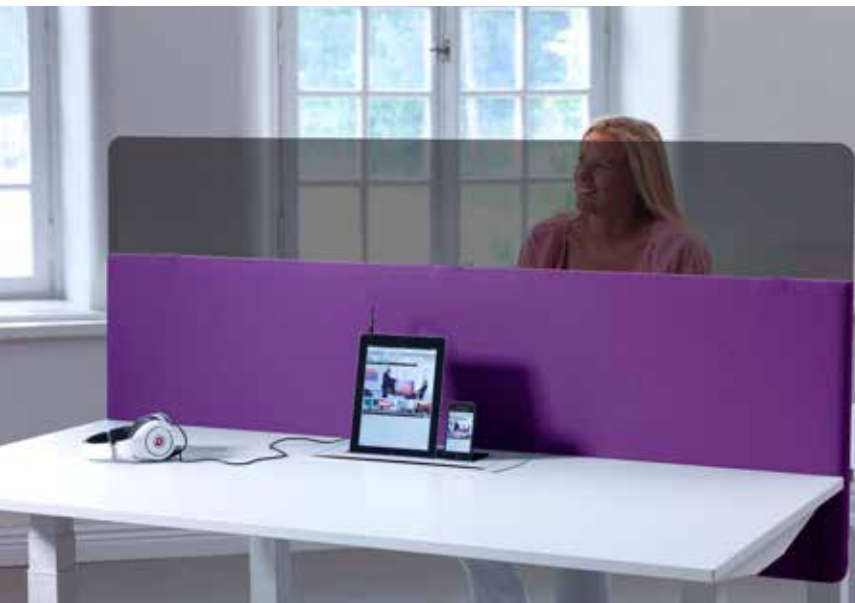

### SCREENIT A30 WITH SMOKED PLEXI

## SCREENIT A30 PLEXI

**Art.No**    **Size/Description**  
*(all dimensions in mm)*

**SCREENIT A30 WITH PLEXI 8 mm**    *See price ranges on page 8-11*



#### A30 with transparent plexi

654080	W. 800 H. 800
654120	W. 1200 H. 800
654140	W. 1400 H. 800
654160	W. 1600 H. 800
654180	W. 1800 H. 800
654200	W. 2000 H. 800

#### A30 with frosted plexi

657080	W. 800 H. 800
657120	W. 1200 H. 800
657140	W. 1400 H. 800
657160	W. 1600 H. 800
657180	W. 1800 H. 800
657200	W. 2000 H. 800

#### A30 with smoked plexi

658080	W. 800 H. 800
658120	W. 1200 H. 800
658140	W. 1400 H. 800
658160	W. 1600 H. 800
658180	W. 1800 H. 800
658200	W. 2000 H. 800

#### Order procedure, see page 13.

Facts: Standard height from desk top 600 mm with clamp. With desk mount 580 mm if desk is 20 mm. Max load 6 kg.  
Height A30: 550 mm, height plexi: 250 mm. Total height: 800 mm.

#### Clamp set for desk screen

For up to 42 mm desks, 2 pcs in one pack.  
641010-1 white -2 black -3 silver

#### Clamp set for desk screen longer than 1800 mm

For up to 42 mm desks, 3 pcs in one pack.  
641056-1 white -2 black -3 silver

#### Clamp set for desk screen

For up to 72 mm desks, 2 pcs in one pack.  
641025-1 white -2 black -3 silver

#### Clamp set for desk screen longer than 1800 mm

For up to 72 mm desks, 3 pcs in one pack.  
641035-1 white -2 black -3 silver

#### Desk mount set for desk screen

To be mounted with screws under the desk, 2 pcs in one pack.  
641020-1 white -2 black -3 silver

#### Desk mount set for desk screen longer than 1800 mm

To be mounted with screws under the desk, 3 pcs in one pack.  
641057-1 white -2 black -3 silver

#### Corner clamp set for A30 desk screen

For clamping side and frontal screens at 90°. For 42 mm desks.  
641050-1 white -2 black -3 silver

#### Corner clamp set for A30 desk screen

For clamping side and frontal screens at 90°. For 72 mm desks.  
641045-1 white -2 black -3 silver

#### Corner mount set for A30 desk screen

For mounting side and frontal screens at 90°.  
641058-1 white -2 black -3 silver

#### Desk mount set for Halfpipe with keyhole

To be mounted with screws under the desk, 2 pcs in one pack.  
642065-1 white -3 silver

#### Cable holder Halfpipe adjustable with keyhole for desk screen

770100	L.1000-1800	W.170	D.80	silver
770100-1	L.1000-1800	W.170	D.80	white

#### Cable holder Halfpipe adjustable for desk screen

760100	L.1000-1800	W.170	D.80	silver
760100-1	L.1000-1800	W.170	D.80	white
760100-8	L.1000-1800	W.170	D.80	black

#### Halfpipe plastic end

740020	silver	-1 white	-2 black
--------	--------	----------	----------

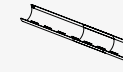
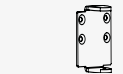
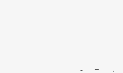
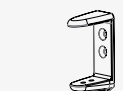

## SCREENIT PLEXI

Desk screen made of acryl. The screens are available in transparent, frosted and smoked plexi.

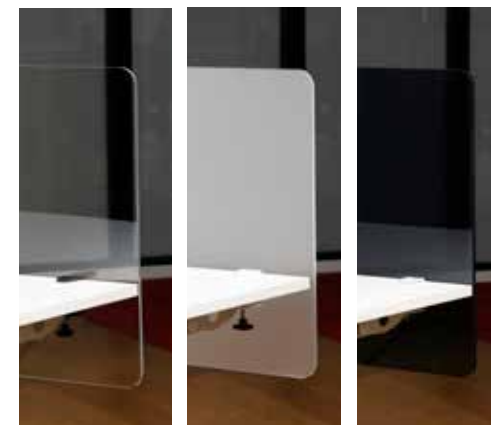

Transparent    Frosted    Smoked

## PLEXI WITH SCREEN PRINT

Ask about our screen printing possibilities for extra visual effects. Contact us for price.



## SCREENIT PLEXI

**Art.No**    **Size/Description**  
*(all dimensions in mm)*

### SCREENIT PLEXI

**ScreenIT Plexi 5 mm**  
*5 mm thick acryl desk screen. Standard height from desk top 450 mm (with desk clamp).*

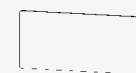

631080	W. 800 H. 650	transparent
631120	W. 1200 H. 650	transparent
631140	W. 1400 H. 650	transparent
631160	W. 1600 H. 650	transparent
631180	W. 1800 H. 650	transparent

633080	W. 800 H. 650	frosted
633120	W. 1200 H. 650	frosted
633140	W. 1400 H. 650	frosted
633160	W. 1600 H. 650	frosted
633180	W. 1800 H. 650	frosted

635080	W. 800 H. 650	smoked
635120	W. 1200 H. 650	smoked
635140	W. 1400 H. 650	smoked
635160	W. 1600 H. 650	smoked
635180	W. 1800 H. 650	smoked

**ScreenIT Plexi 8 mm**  
*8 mm thick acryl desk screen. Standard height from desk top 450 mm (with desk clamp).*

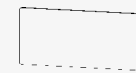

637080	W. 800 H. 650	transparent
637120	W. 1200 H. 650	transparent
637140	W. 1400 H. 650	transparent
637160	W. 1600 H. 650	transparent
637180	W. 1800 H. 650	transparent

638080	W. 800 H. 650	frosted
638120	W. 1200 H. 650	frosted
638140	W. 1400 H. 650	frosted
638160	W. 1600 H. 650	frosted
638180	W. 1800 H. 650	frosted

639080	W. 800 H. 650	smoked
639120	W. 1200 H. 650	smoked
639140	W. 1400 H. 650	smoked
639160	W. 1600 H. 650	smoked
639180	W. 1800 H. 650	smoked

**Clamp set for desk screen**  
*For up to 42 mm desks, 2 pcs in one pack.*

641010-1 white -2 black -3 silver

#### Clamp set for desk screen longer than 1600 mm

*For up to 42 mm desks, 3 pcs in one pack.*  
641056-1 white -2 black -3 silver

**Clamp set for desk screen**  
*For up to 72 mm desks, 2 pcs in one pack.*

641025-1 white -2 black -3 silver

#### Clamp set for desk screen longer than 1600 mm

*For up to 72 mm desks, 3 pcs in one pack.*  
641035-1 white -2 black -3 silver

**Desk mount set for desk screen**  
*To be mounted with screws under the desk, 2 pcs in one pack.*

641020-1 white -2 black -3 silver

#### Desk mount set for desk screen longer than 1600 mm

*To be mounted with screws under the desk, 3 pcs in one pack.*  
641057-1 white -2 black -3 silver

**Desk mount set for Halfpipe with keyhole**  
*To be mounted with screws under the desk, 2 pcs in one pack.*

642065-1 white -3 silver

#### Cable holder Halfpipe adjustable with keyhole for desk screen

770100	L.1000-1800	W.170	D.80	silver
770100-1	L.1000-1800	W.170	D.80	white

Please contact us for special size quotes.



# MOUNTS, TOOLBARS, RAILS, ACCESSORIES

Toolbars enable you to create a practical and efficient workstation. All accessories are within easy reach placed on a suspended third level, keeping the desk surface clear and useable.





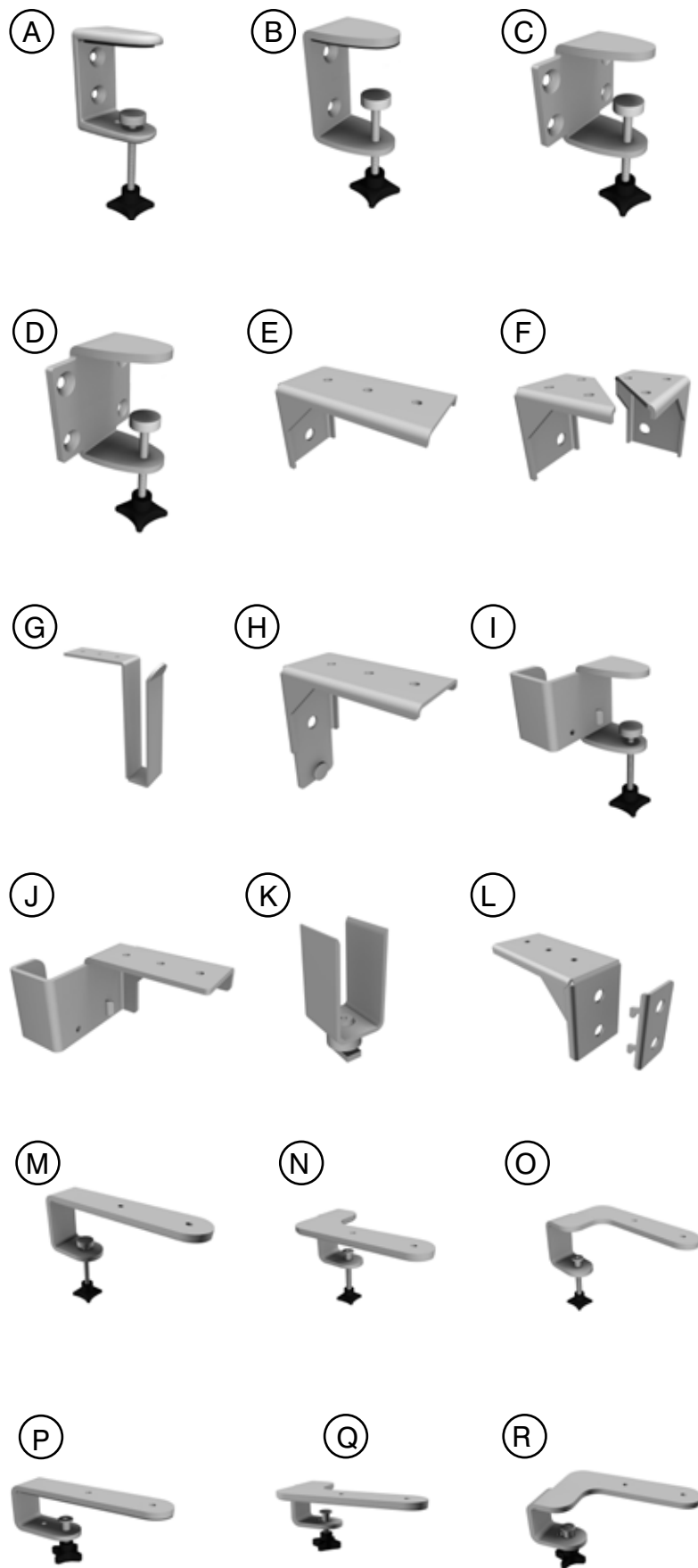



















## MOUNTS





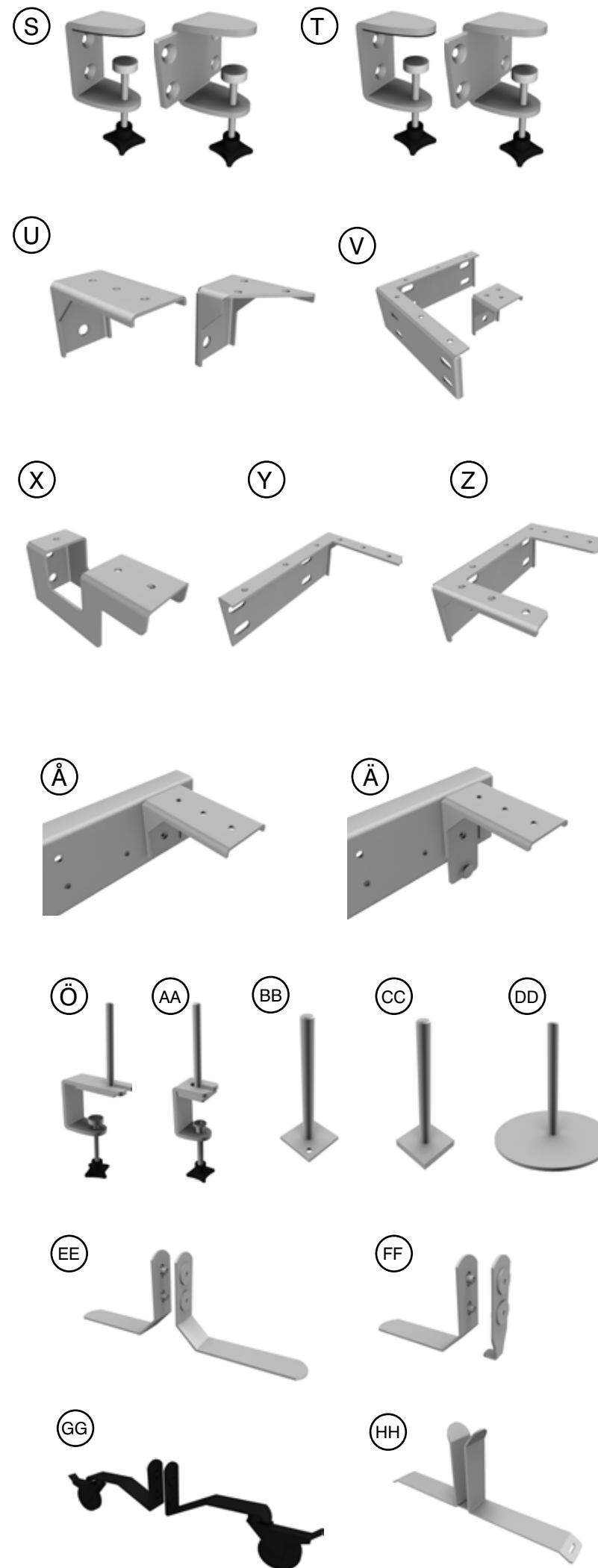













Art.No Size/Description Colour  
(all dimensions in mm)

-  **A** Clamp set for desk screen  
For up to 42 mm desks. 2 pcs in one pack.  
641010-1 white -2 black -3 silver
-  **B** Clamp set for desk screen  
For up to 72 mm desks. 2 pcs in one pack.  
641025-1 white -2 black -3 silver
-  **C** Corner clamp set for A30 desk screen  
For clamping side and frontal screens at 90°. For 42 mm desks.  
2 pcs in one pack.  
641050-1 white -2 black -3 silver
-  **D** Corner clamp set for A30 desk screen  
For clamping side and frontal screens at 90°. For 72 mm desks.  
2 pcs in one pack.  
641045-1 white -2 black -3 silver
-  **E** Desk mount set for desk screen  
To be mounted with screws under the desk, 2 pcs in one pack.  
641020-1 white -2 black -3 silver
-  **F** Corner mount set for A30 desk screen  
For mounting side and frontal screens at 90°. 2 pcs in one pack.  
641058-1 white -2 black -3 silver
-  **G** Desk mount set Slide-in  
2 pcs in one pack.  
641085-1 white, 2 black, 3 silver
-  **H** Desk mount set for Halfpipe with keyhole  
To be mounted with screws under the desk. 2 pcs in one pack.  
642065-1 white -3 silver
-  **I** Desk clamp adjustable for screens without holes  
2 pcs in one pack. For up to 42 mm desks.  
642032-1 white -2 black -3 silver
-  **J** Desk mount adjustable for screens without holes  
Not possible to use 2 mounts in the same angle. 2 pcs in one pack.  
642033-1 white -2 black -3 silver
-  **K** Clamp for desk with aluminium rail  
2 pcs in one pack.  
642062-1 white -2 black -3 silver
-  **L** OnOff Desk mount  
To hook on and off. 2 pcs in one pack.  
642077-1 white -2 black -3 silver
-  **M** Desk clamp for ScreenIT A30 Sidescreen  
For up to 42 mm desks. 1 clamp included.  
642068-1 white -2 black -3 silver
-  **N** Desk clamp right for ScreenIT A30 Sidescreen  
For up to 42 mm desks. 1 clamp included.  
642082-1 white -2 black -3 silver
-  **O** Desk clamp left for ScreenIT A30 Sidescreen  
For up to 42 mm desks. 1 clamp included.  
642083-1 white -2 black -3 silver
-  **P** Desk clamp Small for ScreenIT A30 Sidescreen  
For up to 27 mm desks. 1 clamp included.  
643011-1 white -2 black -3 silver
-  **Q** Desk clamp Small right for ScreenIT A30 Sidescreen  
For up to 27 mm desks. 1 clamp included.  
643012-1 white -2 black -3 silver
-  **R** Desk clamp Small left for ScreenIT A30 Sidescreen  
For up to 27 mm desks. 1 clamp included.  
643013-1 white -2 black -3 silver



## MOUNTS

Art.No Size/Description Colour  
(all dimensions in mm)

-  **S** Clamp set for booth, package  
For up to 42 mm desks. 6 clamps includes. 2 clamps and 4 corner clamps.  
641068-1 white -2 black -3 silver
-  **T** Clamp set for booth, package  
For up to 72 mm desks. 6 clamps includes. 2 clamps and 4 corner clamps.  
641071-1 white -2 black -3 silver
-  **U** Desk mount for desk booth, package  
To be mounted with screws under the desk. 2 desk mount and 4 corner desk mount.  
641069-1 white -2 black -3 silver
-  **V** Desk mount Mini to the desk booth, package  
Assembled with screws under the desk. Four brackets are included. 2 Mini desk mounts and 2 Slim corner mounts.  
642027-1 white -2 black -3 silver
-  **X** Desk mount with recess for a beam  
To be mounted with screws under the desk. 2 pcs in one pack.  
642042-1 white -2 black -3 silver
-  **Y** Desk mount Slim  
To be mounted with screws under the desk. 2 pcs in one pack. Right and left.  
642010-1 white -2 black -3 silver
-  **Z** Desk mount Slim Reinforced  
To be mounted with screws under the desk. 2 pcs in one pack. Right and left.  
643010-1 white -2 black -3 silver
-  **Ä** Slide rail for A30 Slide  
Extruded aluminium slide rail pack. 1 rail/screen.  
668140-1 1400 mm white  
668140-3 1400 mm silver  
For more lengths see page 17.
-  **Ä** Slide rail for A30 Slide for Halfpipe with keyhole  
Extruded aluminium slide rail pack. 1 rail/screen.  
858140-1 1400 mm white  
858140-3 1400 mm silver  
For more lengths see page 17.
-  **Ö** Desk clamp for A30 above desk  
For up to 42 mm desks.  
Content: 2 desk clamp and 2 pins.  
642090-1 white -2 black -3 silver
-  **AA** Desk clamp Small for A30 above desk  
For up to 42 mm desks.  
Content: 2 desk clamp and 2 pins.  
642088-1 white -2 black -3 silver
-  **BB** Pin for A30 above desk  
Content: 2 pins.  
642095-1 white -2 black -3 silver
-  **CC** Pins for A30 above desk, completion  
Content: 2 pins. for achieving the same height as front screen with clamps.  
642089-1 white -2 black -3 silver
-  **DD** Foot for A30 above desk  
Content: Two pins with circular foot, Ø105 mm. Standing on the desk. Felt pads included.  
642093-1 white -2 black -3 silver
-  **EE** Foot set for A30 Floor screen  
4 in one pack.  
641040-1 white -2 black -3 silver
-  **FF** Corner foot set support for angled screens  
4 in one pack. 3 standard and 1 angle.  
Se [www.gotessons.com](http://www.gotessons.com) for instructions.  
641055-1 white -2 black -3 silver
-  **GG** Foot set with wheels for A30 Floor screen  
Lockable wheels. 4 in one pack.  
641065-2 black
-  **HH** Foot set Slide-in for A30 Floor screen  
2 pcs in one pack. L. 505 H. 200  
641075-1 white, -2 black, -3 silver





## FREEWALL DOUBLE TRACK

The toolbar that suits all accessories. It has a double profile concealing the attachment screws. Recommended mounting height: 310 mm above desk to top of the Freewall.



## FREEWALL

The toolbar can be screwed on a desk screen or to a wall. All accessories on pages 36-38 are suitable for the Freewall, Linjé 4Way and most other two line rails. Recommended mounting height: 310 mm above desk to top of the Freewall. The Freewall toolbar can also be fixed directly on the wall or other solid vertical surfaces.

**Tip!**  
For monitor arms and other heavier accessories we recommend the A30 Reinforced with desk mount. See page 19.



## FREEWALL

Art.No Size/Description Colour  
(all dimensions in mm)

### FREEWALL

**Freewall double track**  
Suitable for ScreenIT Standard, A30/A40 Reinforced and wallmount

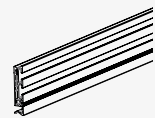

Extruded aluminium rail, 2 end covers and screws included.  
Height 80 mm, width 16 mm.

676075	L. 750	silver
676075-1	L. 750	white*
676115	L. 1150	silver
676115-1	L. 1150	white*
676135	L. 1350	silver
676135-1	L. 1350	white*
676155	L. 1550	silver
676155-1	L. 1550	white*
676175	L. 1750	silver
676175-1	L. 1750	white*
676195	L. 1950	silver
676195-1	L. 1950	white*

### Freewall

Suitable for ScreenIT Standard and wallmount

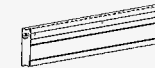

Extruded aluminium rail, 2 end covers and screws included.  
Height 60 mm, width 14 mm. Max load 6 kg.

670075	L. 750	silver
670075-1	L. 750	white*
670115	L. 1150	silver
670115-1	L. 1150	white*
670135	L. 1350	silver
670135-1	L. 1350	white*
670155	L. 1550	silver
670155-1	L. 1550	white*
670175	L. 1750	silver
670175-1	L. 1750	white*
670195	L. 1950	silver
670195-1	L. 1950	white*

### Freewall

Suitable for ScreenIT A30/A40 Reinforced desk screen

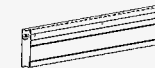

Extruded aluminium rail, 2 end covers and screws included.  
Height 60 mm, width 14 mm. Max load 25 kg.

671075	L. 750	silver
671075-1	L. 750	white*
671115	L. 1150	silver
671115-1	L. 1150	white*
671135	L. 1350	silver
671135-1	L. 1350	white*
671155	L. 1550	silver
671155-1	L. 1550	white*
671175	L. 1750	silver
671175-1	L. 1750	white*
671195	L. 1950	silver
671195-1	L. 1950	white*

\*Delivery time 5-10 days.

For all Freewall accessories, please see page 36-38.



## LINJÉ 4WAY TOOLBAR

Creating a stable 3rd level allows for more workspace and is ideal when working with multiple monitors. Max load 100 kg. Select required accessories shown on page 36-38.



## LINJÉ 4WAY TOOLBAR

With 700 mm posts, toolbar rail and six D-Zine Toolbar 1 for the monitors. Both posts and rails are available in various lengths and heights.

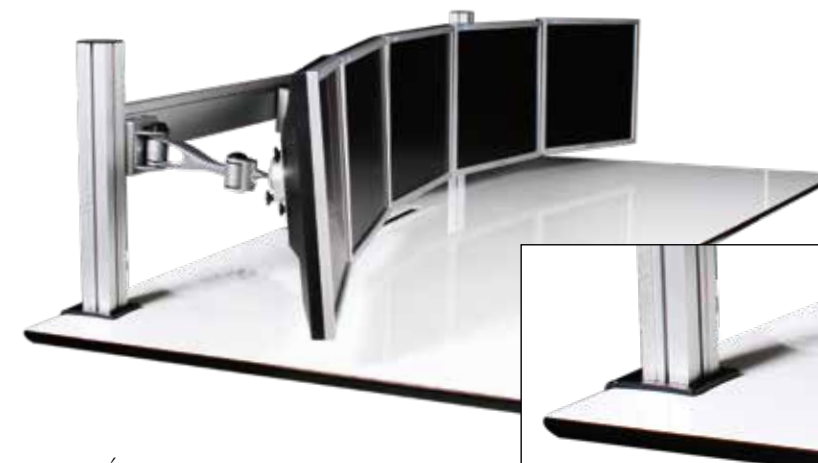

## LINJÉ 4WAY TOOLBAR

With five monitors.

Clamp Small

## LINJÉ 4WAY TOOLBAR

Art.No Size/Description Colour  
(all dimensions in mm)

### LINJÉ 4WAY TOOLBAR

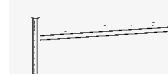

Toolbar rail with 2x400 mm posts, 2 desk clamps.

692140	1400 mm Clamp	silver
692140-1	1400 mm Clamp	white*
692160	1600 mm Clamp	silver
692160-1	1600 mm Clamp	white*
692180	1800 mm Clamp	silver
692180-1	1800 mm Clamp	white*

As shown on all pictures the Clamp small are more discrete.  
For up to 42 mm desks.

694140	1400 mm Clamp small	silver
694140-1	1400 mm Clamp small	white*
694160	1600 mm Clamp small	silver
694160-1	1600 mm Clamp small	white*
694180	1800 mm Clamp small	silver
694180-1	1800 mm Clamp small	white*

Toolbar rail with 2x400 mm posts, 2 desk mounts.

693140	1400 mm Desk mount	silver
693140-1	1400 mm Desk mount	white*
693160	1600 mm Desk mount	silver
693160-1	1600 mm Desk mount	white*
693180	1800 mm Desk mount	silver
693180-1	1800 mm Desk mount	white*

Posts and arms are made of extruded aluminium.  
The attachments are casted in aluminium.  
Rail length, see [www.gotessons.com](http://www.gotessons.com).

For all Toolbar accessories, please see page 36-38.



### Linjé Clamp

Builds 20 mm from desk.

66001		silver
66001-1		white



### Linjé Clamp Small

Builds 10 mm from desk.

66123		black
66123-1		white



### Linjé Desk mount

66002		silver
66002-1		white



### Linjé rail

689140	1400 mm	silver
689140-1	1400 mm	white*
689160	1600 mm	silver
689160-1	1600 mm	white*
689180	1800 mm	silver
689180-1	1800 mm	white*

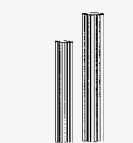

### Linjé post

692040	400 mm	silver
692040-1	400 mm	white
692070	700 mm	silver
692070-1	700 mm	white

\*Delivery time 5-10 days.





Laptop shelf for monitor arm



Tarifold holder for monitor arm



Tarifold holder with clamp



Pen tray



Hand



Tulip LED Lamp

Tip!  
Please read more  
about Tulip at page  
108-109.

## TOOLBAR ACCESSORIES

Art.No Size/Description Colour  
(all dimensions in mm)

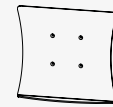

### Laptop shelf for monitor arm

Laptop shelf for arm mount. (See arms on next page).  
Incl. velcro and elastics.

671097	350x320 mm	silver
671097-1	350x320 mm	white
671097-2	350x320 mm	black



### Tarifoldholder for monitor arm

671090	W. 156 H. 352	silver
671090-1	W. 156 H. 352	white
671090-2	W. 156 H. 352	black

671080 A4 Plastic folder for tarifold  
Tarifold for max 10 plastic holders (A4). To be fitted onto a toolbar.



### Tarifoldholder with clamp

671050	W. 144 H. 352	silver
671050-1	W. 144 H. 352	white

To attach at toolbar or Freewall rail. For max 10 plastic holders (A4).



671080	A4 Plastic folder for tarifold	
--------	--------------------------------	--



671081	Pen tray	silver
671081-1	W. 62 H. 80 D. 68	white



674000	Right Hand	silver
674000-1	W. 120 D. 180	white



674005	Left Hand	silver
674005-1	W. 120 D. 180	white



### Tulip LED Lamp

Desk lamp with USB charger.  
821005 See drawing page 108. white/black



### Tray for Tulip for Freewall

W. 172 H. 190  
671087-1 white -2 black



ZAP TOOLBAR 3



D-ZINE TOOLBAR 3

## TOOLBAR ARMS

Art.No Size/Description Colour  
(all dimensions in mm)

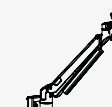

### ZAP Toolbar 3

Gas arm. Incl. toolmount. Weight span 1,5-7 kg.  
616525 L. 505 H. 399 silver  
616525-1 L. 505 H. 399 white  
616525-2 L. 505 H. 399 black



### D-Zine Toolbar 1

Max weight 12 kg.  
611525 L. 130 H. 135 silver  
611525-1 L. 130 H. 135 white  
611525-2 L. 130 H. 135 black



### D-Zine Toolbar 2

Max weight 12 kg.  
611526 L. 315 H. 135 silver  
611526-1 L. 315 H. 135 white  
611526-2 L. 315 H. 135 black

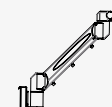

### D-Zine Toolbar 3

Gas arm. Incl. toolmount. Weight span 1,5-8,5 kg.  
611325 L. 470 H. 360 silver  
611325-1 L. 470 H. 360 white  
611325-2 L. 470 H. 360 black

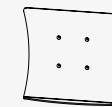

### Laptop shelf for monitor arm

Laptop shelf for arm mount. Incl. velcro and elastics.

671097	350x320 mm	silver
671097-1	350x320 mm	white
671097-2	350x320 mm	black

For VESA adapters, see page 116.

D-Zine Toolbar 3

D-Zine Toolbar 2

D-Zine Toolbar 1





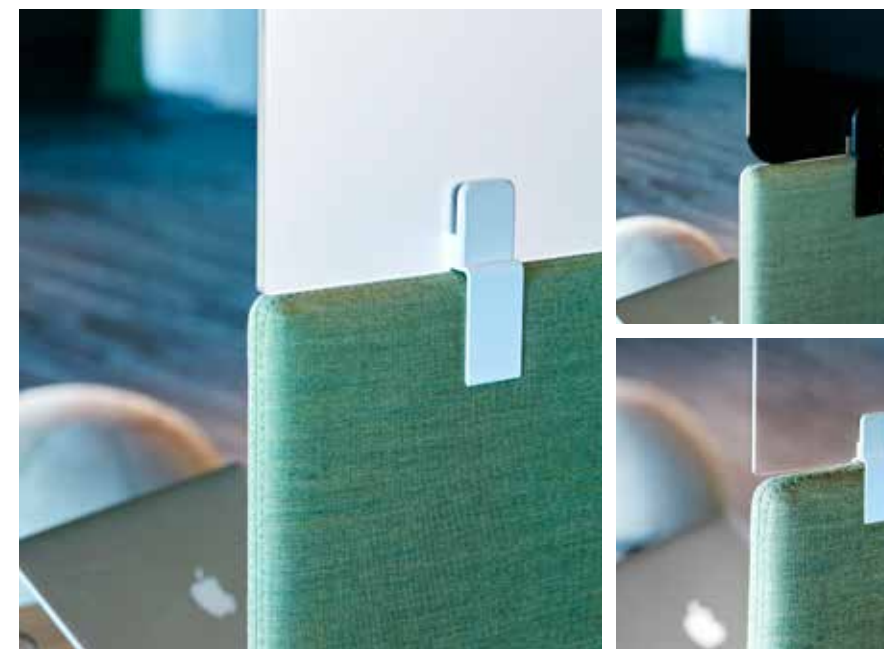

## ACCESSORIES FOR SCREENS

Flexibly plexitop for shielding between working stations. The smoked plexitop limits certain sundrop, easy to move around. Can be placed on any A30 screens to increase height.

Accessories to be hanged over the screen. Both in transparent plexi and metal for ScreenIT Standard and A30. No rail required.

## ACCESSORIES FOR SCREENS

Art.No Size/Description  
(all dimensions in mm)

### SCREEN ACCESSORIES

#### Plexitop 8 mm

To be mounted on the screen. Suitable for ScreenIT A30.

451080	W. 800	H. 250	transparent
451120	W. 1200	H. 250	transparent
451140	W. 1400	H. 250	transparent
451160	W. 1600	H. 250	transparent
451180	W. 1800	H. 250	transparent
451200	W. 2000	H. 250	transparent
452080	W. 800	H. 250	frosted
452120	W. 1200	H. 250	frosted
452140	W. 1400	H. 250	frosted
452160	W. 1600	H. 250	frosted
452180	W. 1800	H. 250	frosted
452200	W. 2000	H. 250	frosted
453080	W. 800	H. 250	smoked
453120	W. 1200	H. 250	smoked
453140	W. 1400	H. 250	smoked
453160	W. 1600	H. 250	smoked
453180	W. 1800	H. 250	smoked
453200	W. 2000	H. 250	smoked

#### Clamp for Plexitop

Suitable for ScreenIT A30. 2 pcs in one pack.  
642074-1 white -2 black

#### Clamp for Plexitop longer than 1600 mm

Suitable for ScreenIT A30. 3 pcs in one pack.  
642076-1 white -2 black



#### Name tag plexi for ScreenIT Standard

With slide in pocket for business cards.

637103 W. 130 H. 63 transparent

#### Name tag plexi for ScreenIT A30

With slide in pocket for business cards.

637104 W. 130 H. 63 transparent



#### Whiteboard for ScreenIT Standard

Magnetic whiteboard in metal.

648105 W. 500 H. 350 D. 53 whiteb. white

#### Whiteboard for ScreenIT A30

Magnetic whiteboard in metal.

648106 W. 500 H. 350 D. 53 whiteb. white

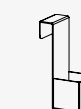

#### Pen tray for ScreenIT Standard

Pen tray in transparent plexi or metal to be hanged over the screen.

637106 W. 90 H. 253 D. 90 transparent

637114-1 W. 90 H. 253 D. 90 white

637114-3 W. 90 H. 253 D. 90 silver

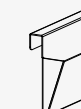

#### Pen tray for ScreenIT A30

Pen tray in transparent plexi or metal to be hanged over the screen.

637105 W. 90 H. 253 D. 90 transparent

637111-1 W. 90 H. 253 D. 90 white

637111-3 W. 90 H. 253 D. 90 silver



#### A4 tray for ScreenIT Standard

A4 tray in transparent plexi or metal to be hanged over the screen.

637108 W. 320 H. 253 D. 80 transparent

637115-1 W. 320 H. 253 D. 80 white

637115-3 W. 320 H. 253 D. 80 silver



#### A4 tray plexi for ScreenIT A30

A4 tray in transparent plexi or metal to be hanged over the screen.

637107 W. 320 H. 253 D. 80 transparent

637112-1 W. 320 H. 253 D. 80 white

637112-3 W. 320 H. 253 D. 80 silver



#### A4 shelf for ScreenIT Standard

A4 shelf in metal to be hanged over the screen.

637116-1 W. 320 H. 150 D. 250 white

637116-3 W. 320 H. 150 D. 250 silver



#### A4 shelf for till ScreenIT A30

A4 shelf in metal to be hanged over the screen.

637113-1 W. 320 H. 150 D. 250 white

637113-3 W. 320 H. 150 D. 250 silver



#### Hook for ScreenIT A30

Hook in metal to be hanged over the screen ex headset or jacket.

671098 W. 60 H. 100 D. 48 silver

671098-1 W. 60 H. 100 D. 48 white

671098-2 W. 60 H. 100 D. 48 black



#### Whiteboard for ScreenIT A30 Floor screen

Magnetic whiteboard in metal.

648103 W. 700 H. 900 D. 50 whiteb. white

648104 W. 700 H. 700 D. 50 whiteb. white



Power Shelf

A pull-out slide shelf with 3 sockets and a hole for retractable cables.



Laptop holder



Post tray



Multitray



Binder shelf



File holder



Magnetic memo board

## TOOLBAR/SCREEN ACCESSORIES

Art.No Size/Description  
(all dimensions in mm)

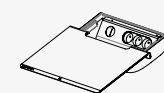

673003 Power Shelf silver  
673003-1 W. 370 H. 115 D. 300 white

The shelf can slide open. When closed keeping all cables out of sight. The Power shelf contains 3 electrical sockets and a hole for retractable cables. Standard CEEchuko sockets. Cable length 1,5 m. Suits all Gotessons rails and is also available with desk clamp, see page 126.

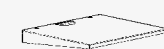

671010 Toolbar Laptop holder small silver  
671010-1 W. 360 H. 50 D. 290 white



671020 Toolbar Laptop holder big silver  
671020-1 W. 460 H. 50 D. 370 white



671040 Post tray silver  
671040-1 W. 320 H. 65 D. 250 white



671070 Multitray silver  
671070-1 W. 340 H. 250 D. 260 white



671084 Binder shelf silver  
671084-1 W. 320 H. 184 D. 250 white



671085 Binder shelf adjustable silver  
671085-1 W. 340 H. 250 D. 260 white



671083 File holder (9 files) silver  
671083-1 W. 385 H. 300 D. 256 white



671030 Magnet board silver  
671030-11 Magnet board w. whiteboard white  
W. 280 H. 300





# FLOOR SCREENS ROOM WITHIN A ROOM

In today's open office landscape, floor screens can make the big difference for the working climate. Screens that form room in the room, screens that take care of noise and buzz from office machines, writing on keyboards and talking colleagues. Everything from flexible screens to room divider and booths can be found on these pages. Do not miss The Hut Collection, this year has been expanded with several new exciting products.





## SCREENIT A30 FLOOR SCREEN

A30 Floor screen provides a stable, stylish and practical shielding in open plan areas with an A-classed noise absorption.

## SCREENIT A30 FLOOR SCREEN WITH PLEXI

A30 Floorscreen with a plexi screen top. Can only be ordered with seam.



## SCREENIT A30 FLOOR SCREEN

Art.No Size/Description  
(all dimensions in mm)

### SCREENIT A30 SOUND ABSORBING FLOOR SCREEN

See price ranges on page 8-11.



#### A30 floor screen with seam

632120	W. 800 H. 1200
632140	W. 800 H. 1400
632160	W. 800 H. 1600
632180	W. 800 H. 1800
634120	W. 1000 H. 1200
634140	W. 1000 H. 1400
634160	W. 1000 H. 1600
636120	W. 1200 H. 1200
636140	W. 1200 H. 1400
636160	W. 1200 H. 1600
669120	W. 1400 H. 1200
669140*	W. 1400 H. 1400
669160*	W. 1400 H. 1600
669180*	W. 1400 H. 1800
653120	W. 1600 H. 1200
653140*	W. 1600 H. 1400
653160*	W. 1600 H. 1600

#### A30 floor screen with zip

632120	W. 800 H. 1200
632140	W. 800 H. 1400
632160	W. 800 H. 1600
632180	W. 800 H. 1800
634120	W. 1000 H. 1200
634140	W. 1000 H. 1400
634160	W. 1000 H. 1600
636120	W. 1200 H. 1200
636140	W. 1200 H. 1400
636160	W. 1200 H. 1600
669120	W. 1400 H. 1200
669140*	W. 1400 H. 1400
669160*	W. 1400 H. 1600
669180*	W. 1400 H. 1800
653120	W. 1600 H. 1200
653140*	W. 1600 H. 1400
653160*	W. 1600 H. 1600

Order procedure, see page 13.

### SCREENIT A30 SOUND ABSORBING FLOOR SCREEN WITH TRANSPARENT PLEXI TOP 8 MM

See price ranges on page 8-11.



#### A30 floor screen with seam

156120	W. 800 H. 1200
156140	W. 800 H. 1400
156160	W. 800 H. 1600
156180	W. 800 H. 1800
143120	W. 1000 H. 1200
143140	W. 1000 H. 1400
143160	W. 1000 H. 1600
147120	W. 1200 H. 1200
147140	W. 1200 H. 1400
147160	W. 1200 H. 1600
150120	W. 1400 H. 1200
150140*	W. 1400 H. 1400
150160*	W. 1400 H. 1600
150180*	W. 1400 H. 1800
153120	W. 1600 H. 1200
153140*	W. 1600 H. 1400
153160*	W. 1600 H. 1600

The above screens are also available with frosted and smoked plexitop. See [www.gotessons.com](http://www.gotessons.com) for article number and price. Can only be ordered with seam. (not zip due to construction).

Facts: Height plexi: 250 mm. (Included in height measurement)

#### Foot set for A30 Floor screen

4 in one pack.

641040-1 white -2 black -3 silver

#### Corner foot set support for angled screens

4 in one pack.

641055-1 white -2 black -3 silver

#### Foot set with wheels for A30 Floor screen

Lockable wheels. 4 in one pack.

641065-2 black

For floor screen accessories, please see page 39.

\*Screens ordered with textiles: Noble Lux, Radio, Houston Reflect, Artificial Leather, Blazer, Synergy and Remix 2 will be with a decor seam.



## SCREENIT A40 FLOOR SCREEN, STRAIGHT CORNER

A40 straight corner is a stylish rectangular floor screen, a good sound absorber/room divider with a total thickness of 50 mm. Also available as desk screen, information on page 26.

## DECOR SEAM

For screens with width over 1200 mm, we might add an extra seam when the textile width not is sufficient.\*



#### Foot set for A40 Floor screen

4 in one pack.

642015-1 white -2 black -3 silver

#### Corner foot set support for angled screens

4 in one pack.

642035-1 white -2 black -3 silver

#### Foot set with wheels for A40 Floor screen

Lockable wheels. 4 in one pack.

642025-2 black

For floor screen accessories, please see page 36-39.

## SCREENIT A30/A40 FLOOR SCREEN

Art.No Size/Description  
(all dimensions in mm)

### SCREENIT A30 FLOOR SCREEN STRAIGHT CORNER

See price ranges on page 8-11.



#### A30 straight corner with seam

532120	W. 800 H. 1200
532140	W. 800 H. 1400
532160	W. 800 H. 1600
532180	W. 800 H. 1800
534120	W. 1000 H. 1200
534140	W. 1000 H. 1400
534160	W. 1000 H. 1600
536120	W. 1200 H. 1200
536140	W. 1200 H. 1400
536160	W. 1200 H. 1600
569120	W. 1400 H. 1200
569140*	W. 1400 H. 1400
569160*	W. 1400 H. 1600
569180*	W. 1400 H. 1800
553120	W. 1600 H. 1200
553140*	W. 1600 H. 1400
553160*	W. 1600 H. 1600

#### A30 straight corner with zip

532120	W. 800 H. 1200
532140	W. 800 H. 1400
532160	W. 800 H. 1600
532180	W. 800 H. 1800
534120	W. 1000 H. 1200
534140	W. 1000 H. 1400
534160	W. 1000 H. 1600
536120	W. 1200 H. 1200
536140	W. 1200 H. 1400
536160	W. 1200 H. 1600
569120	W. 1400 H. 1200
569140*	W. 1400 H. 1400
569160*	W. 1400 H. 1600
569180*	W. 1400 H. 1800
553120	W. 1600 H. 1200
553140*	W. 1600 H. 1400
553160*	W. 1600 H. 1600

### SCREENIT A40 FLOOR SCREEN STRAIGHT CORNER

#### A40 straight corner with seam

537120	W. 800 H. 1200
537140	W. 800 H. 1400
537160	W. 800 H. 1600
537180	W. 800 H. 1800
533120	W. 1000 H. 1200
533140	W. 1000 H. 1400
533160	W. 1000 H. 1600
555120	W. 1200 H. 1200
555140	W. 1200 H. 1400
555160	W. 1200 H. 1600
554120	W. 1400 H. 1200
554140*	W. 1400 H. 1400
554160*	W. 1400 H. 1600
554180*	W. 1400 H. 1800
557120	W. 1600 H. 1200
557140*	W. 1600 H. 1400
557160*	W. 1600 H. 1600

#### A40 straight corner with zip

537120	W. 800 H. 1200
537140	W. 800 H. 1400
537160	W. 800 H. 1600
537180	W. 800 H. 1800
533120	W. 1000 H. 1200
533140	W. 1000 H. 1400
533160	W. 1000 H. 1600
555120	W. 1200 H. 1200
555140	W. 1200 H. 1400
555160	W. 1200 H. 1600
554120	W. 1400 H. 1200
554140*	W. 1400 H. 1400
554160*	W. 1400 H. 1600
554180*	W. 1400 H. 1800
557120	W. 1600 H. 1200
557140*	W. 1600 H. 1400
557160*	W. 1600 H. 1600

Order procedure, see page 13.

\*Screens ordered with textiles: Noble Lux, Radio, Houston Reflect, Artificial Leather, Blazer, Synergy and Remix 2 will be with a decor seam.





## SCREENIT A30 THE RISING

Art.No Size/Description  
(all dimensions in mm)

ScreenIT A30 The Rising *See price ranges on page 8-11.*

### ScreenIT A30 with seam

641400 W. 1300 H. 1010  
641600 W. 1500 H. 1010  
641800 W. 1700 H. 1010

### ScreenIT A30 with zip

641400 W. 1300 H. 1010  
641600 W. 1500 H. 1010  
641800 W. 1700 H. 1010

### Stand for The Rising, frosted

Width: 1400 mm. Suitable for screen 1300 mm.  
661400 -1 white -2 black -3 silver

### Stand for The Rising, frosted

Width: 1600 mm. Suitable for screen 1500 mm.  
661600 -1 white -2 black -3 silver

### Stand for The Rising, frosted

Width: 1800 mm. Suitable for screen 1700 mm.  
661800 -1 white -2 black -3 silver

### Stand for The Rising, smoked

Width: 1400 mm. Suitable for screen 1300 mm.  
671400 -1 white -2 black -3 silver

### Stand for The Rising, smoked

Width: 1600 mm. Suitable for screen 1500 mm.  
671600 -1 white -2 black -3 silver

### Stand for The Rising, smoked

Width: 1800 mm. Suitable for screen 1700 mm.  
671800 -1 white -2 black -3 silver

### Foot set for The Rising

4 pcs in a pack, 2 pcs left and 2 pcs right.  
648000 -1 white -2 black -3 silver

### SUPPLEMENTS FOR THE RISING

#### Corner profile for The Rising

To connecting stands together in an angle.  
Add feet below.  
648020 -1 white -2 black -3 silver

#### Foot set for The Rising

To connecting stands together with a corner profile. 2 in a pack: 1 pc left and 1 pc right.

648010 -1 white -2 black -3 silver

#### Order procedure for The Rising:

1. Choose screen - choose stand and glass - choose foot set.
2. Add a corner profile if placed in an angle or in a row.
3. Order Foot set.

Specify the article number for the screen as follow:  
Screen A30 The Rising - textile colour - zip/seam colour.  
Ex 641600-01-101.

Facts: Measurement: adjustable height 1100-1800 mm.  
When placing screens in an angle, use the corner profile  
for connecting stands and complete with 2 pack foot set.

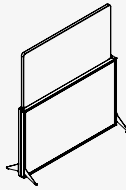

PATENT PENDING  
**THE RISING**

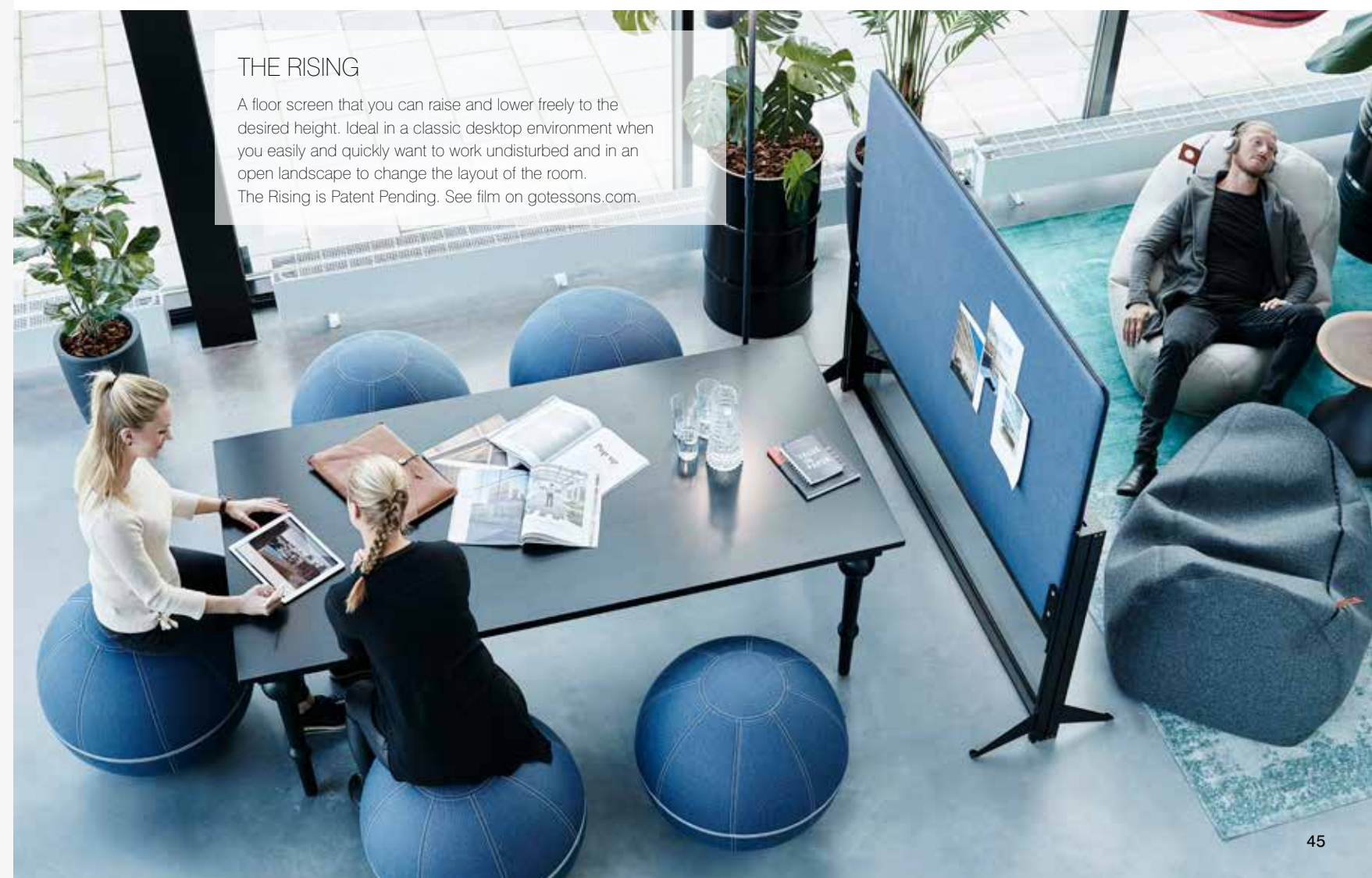

### THE RISING

A floor screen that you can raise and lower freely to the desired height. Ideal in a classic desktop environment when you easily and quickly want to work undisturbed and in an open landscape to change the layout of the room. The Rising is Patent Pending. See film on gotessons.com.



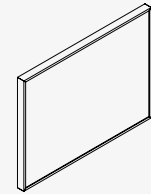

## BLOCK SOUND ABSORBING SCREEN

**Art.No**    **Size/Description**  
(all dimensions in mm)

### BLOCK SOUND ABSORBING SCREEN

Block is used to create temporary rooms in schools, offices and public buildings. Total thickness 120 mm.

200150    W. 2000 H. 1500

#### Foot set for Block

2 in one pack.  
642078-1 white -2 black -3 grey

Facts: Can only be ordered in Hush textile. Can be ordered in different colors of Hush on front and back.

#### Order procedure for Block:

1. Screen  
Specify the article number for the screen as follow:  
Screen - colour frame - textile side 1 - textile side 2.  
Ex 200150-1-560-560.

2. Order Foot set.

See Hush textiles and frame colours at page 8-11.  
Colour frame. 1=white, 2=black, 3=grey

## BLOCK SOUND ABSORBING SCREEN

Block has a 50 mm sound absorber on each side of wood material, for good sound absorption and for stability. Block measures 1500 x 2000 x 120 mm in order to reduce sound propagation but also to create the feeling of a wall. The absorption material is made of our unique core material EcoSUND.



## TOWER BOOTH

The screens in the Tower Booth have double half zips therefor additional screens can be added on at a later date to create multiple attached workstations.

## SCREENIT A30 TOWER BOOTH

**Art.No**    **Size/Description**  
(all dimensions in mm)

### TOWER BOOTH E

Height: 1237 mm. Depth 850 mm. Adapted for a cabinet of width 440 mm. For all measurements, see [www.gotessons.com](http://www.gotessons.com).

See price ranges on page 8-11.

#### Tower Booth E

50120E    W. desk 1200  
50140E    W. desk 1400  
50160E    W. desk 1600  
50180E    W. desk 1800

### TOWER BOOTH M

Height: 1257 mm. Depth 850 mm. Adapted for a cabinet of width 410 mm. For all measurements, see [www.gotessons.com](http://www.gotessons.com).

See price ranges on page 8-11.

#### Tower Booth M

50120M    W. desk 1200  
50140M    W. desk 1400  
50160M    W. desk 1600  
50180M    W. desk 1800

### TOWER BOOTH K

Height: 1287 mm. Depth 850 mm. Adapted for a cabinet of width 410 mm. For all measurements, see [www.gotessons.com](http://www.gotessons.com).

See price ranges on page 8-11.

#### Tower Booth K

50120K    W. desk 1200  
50140K    W. desk 1400  
50160K    W. desk 1600  
50180K    W. desk 1800

Order procedure, see page 13.

byAM Acoustics







## A30 PEAK DESIGN BOOTH

Peak Design Booth is a booth solution with a slight tilted side screen to create dynamics and openness. The booth is coupled with zipper and can therefore be built in infinity. The height is as standard 1400 mm and the side screens have two different depths either 850 mm or 1200 mm. Select screens in the same textile or in a color scale as below to create unique workplaces. Keep clean and tidy around and under the desk by choosing a recessed cable grommet in the screens.

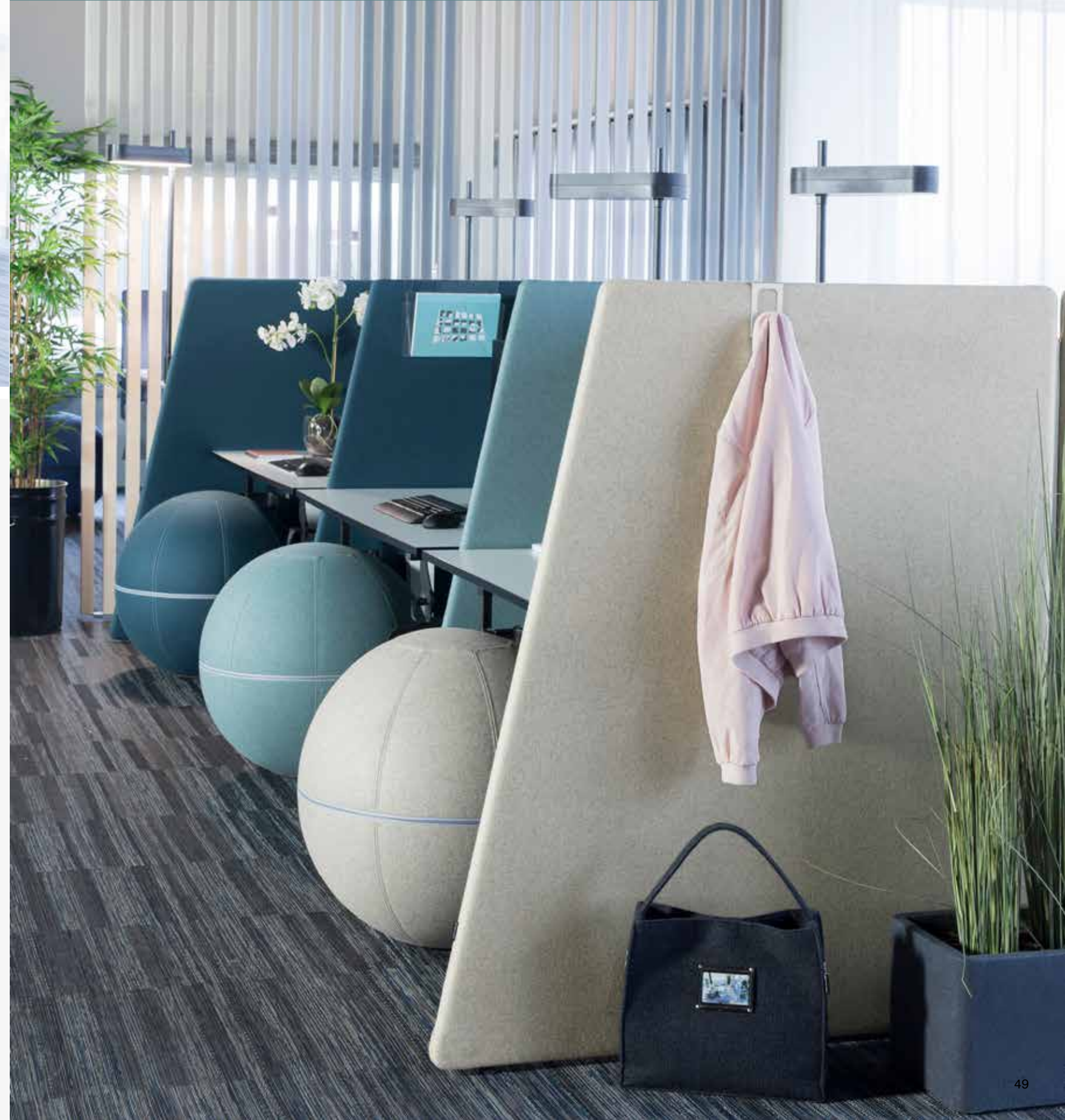

## A30 PEAK DESIGN BOOTH

Art.No Size/Description  
(all dimensions in mm)

### A30 PEAK DESIGN BOOTH

#### Front screen without grommet

119140\* W. 1400 H. 1400  
119160\* W. 1600 H. 1400  
119180\* W. 1800 H. 1400

See price ranges on page 8-11.

#### Front screen with grommet Ø60

119141\* W. 1400 H. 1400  
119161\* W. 1600 H. 1400  
119181\* W. 1800 H. 1400

#### Side screen big without grommet

129124 W. 1200 H. 1400

See price ranges on page 8-11.

#### Side screen big with grommet Ø60

119125 W. 1200 H. 1400

#### Side screen small without grommet

119854 W. 850 H. 1400

See price ranges on page 8-11.

#### Side screen small with grommet Ø60

119855 W. 850 H. 1400

Important information: Mounted feet included. Can only be ordered with seam. Zipper is only used to connect screens. Not available with fishbone zip.

For other sizes request a quote.

For floor screen accessories, please see page 39.

\*Screens ordered with textiles: Noble Lux, Radio, Houston Reflect, Artificial Leather, Blazer, Synergy och Remix 2 will be with a decor seam.



The A30 Peak Design Booth is add-on in infinity.  
Build on with the number of front and middle screens as desired.

If you need help to order please contact Götessons.  
For more solutions see [www.gotessons.com](http://www.gotessons.com).







## SCREENIT A30 BOOTH

Art.No Size/Description  
(all dimensions in mm)

### SCREENIT A30 BOOTH

See price ranges on page 8-11.

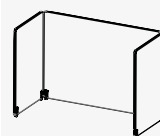

**Booth with black feet**  
852120 W. 1200 H. 1400  
852140\* W. 1400 H. 1400  
852160\* W. 1600 H. 1400  
852180\* W. 1800 H. 1400

Order procedure, see page 13.

For other sizes request a quote.

For floor screen accessories, please see page 39.

\*Screens over 1200 mm ordered with textiles: Noble Lux, Radio, Houston Reflect, Artificial Leather, Blazer, Synergy and Remix 2 will be with a decor seam.



## ADJUSTABLE FEET

Floor screen booths include adjustable feet.  
Adjustable up to 50 mm.

## SCREENIT A30 BOOTH

The floor screens are zipped together to form a booth on adjustable feet. Pricelist height is **1400 mm** and side screens width is **800 mm**. Feet are included. The booth screens are with seam. The zipper is to connect the screens together. Not available with fishbone zip. For other sizes, request a quote.



## SCREENIT A30 BOOTH

Art.No Size/Description  
(all dimensions in mm)

### SCREENIT A30 BOOTH WITH FOUR SCREENS

See price ranges on page 8-11.

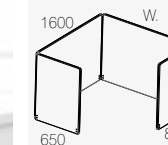

**Booth with black feet**  
1178140\* W. 1400 H. 1400  
1178160\* W. 1600 H. 1400  
1178180\* W. 1800 H. 1400

### SCREENIT A30 BOOTH

See price ranges on page 8-11

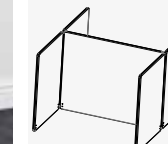

**Booth two desks black feet**  
1161140\* W. 1400 H. 1400  
1161160\* W. 1600 H. 1400  
1161180\* W. 1800 H. 1400

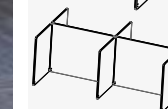

**Booth four desks black feet**  
1162140\* W. 1400 H. 1400  
1162160\* W. 1600 H. 1400  
1162180\* W. 1800 H. 1400

Order procedure, see page 13.

Mounted feet are included. The screens are always with seam, zippers are used for binding screens together. Can not be ordered with fishbone zippers. **For other sizes request a quote.**

For floor screen accessories, please see page 39.

\*Screens over 1200 mm ordered with textiles: Noble Lux, Radio, Houston Reflect, Artificial Leather, Blazer, Synergy and Remix 2 will be with a decor seam.

Tip!

See accessories to hang on the screen at page 39.

## SCREENIT A30 BOOTH WITH FOUR SCREENS

Booth is available in a number of variants. We can also customize. See A30 Booth with four screens above. Pricelist height is **1400 mm**.

## A30 BOOTH

With a double zip on both sides the booth can be increased in length as in picture below. Pricelist height is **1400 mm** and side screens' width is **900 mm**. For other sizes, please contact Gotessons.

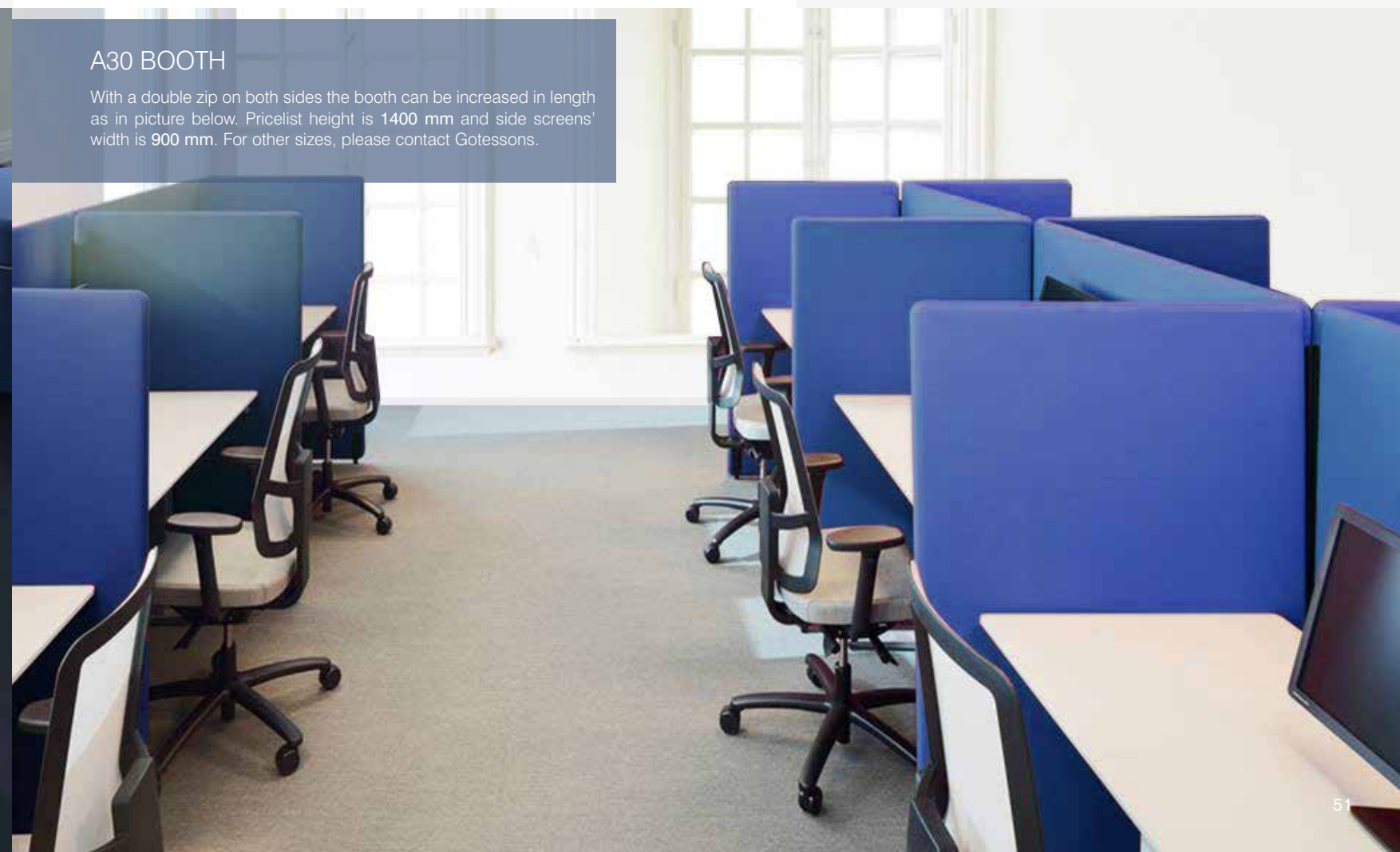





byAM Acoustics

## EFFEKT ECOSUND CEILING

An effective way to improve the acoustics of a room without having to change existing installations such as ventilation, cables, lights, etc. is to mount Effect ceiling absorbers. With even distribution based on the needs of the local area, it becomes an affordable solution that reduces a lot of audio spread in the longitudinal direction of the room. Customize your absorbers by choosing from three core materials and laminate them with the Hush textile, available in several different colors.



## EFFEKT ECOSUND

**Art.No**    **Size/Description**    **Colour**  
(all dimensions in mm)

### Sound Off EcoSUND rectangular without lamps

125120	1200x300x50	raw
125121	1200x300x50	dressed
125122	1200x600x50	raw
125123	1200x600x50	dressed
125124	1200x900x50	raw
125125	1200x900x50	dressed

### HOW TO ORDER EFFEKT ECOSUND RAW

Art.No - Colour core.

Example: 125122-2 = Effekt EcoSUND 1200x600x50 with black core/raw.

### HOW TO ORDER EFFEKT ECOSUND WITH HUSH

Art.No - Colour textile - Edge colour (core/raw).

Example: 125123-567-1 = Effekt EcoSUND 1200x600x50 with blue Hush and white edge.(core/raw).

Facts: Effekt dressed can only be ordered in Hush textile. See textiles and core material on page 8-11.

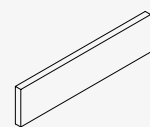

### EFFEKT HANG WIRES

Hang wire to hang Effekt EcoSund in ceiling or under already existing Effekt.

#### Hanger 300 mm

Suitable for Effekt EcoSUND 1200x300x50.

643000-1 white -2 black -3 silver  
643000-15 pearl gold -16 brilliant blue -17 olive green

#### Hanger 600 mm

Suitable for Effekt EcoSUND 1200x600x50.

646000-1 white -2 black -3 silver  
646000-15 pearl gold -16 brilliant blue -17 olive green

#### Hanger 900 mm

Suitable for Effekt EcoSUND 1200x900x50.

649000-1 white -2 black -3 silver  
649000-15 pearl gold -16 brilliant blue -17 olive green



### EFFEKT WIRE HOOKS

Wire hooks to get space when using Effekt EcoSund as a room divider.

#### Space Divider 300 mm

Use to get space between Effekt EcoSUND 1200x300x50 when used as a divider.

643001-1 white -2 black -3 silver  
643001-15 pearl gold -16 brilliant blue -17 olive green

#### Space Divider 600 mm

Use to get space between Effekt EcoSUND 1200x600x50 when used as a divider.

646001-1 white -2 black -3 silver  
646001-15 pearl gold -16 brilliant blue -17 olive green

#### Space Divider 900 mm

Use to get space between Effekt EcoSund 1200x900x50 when used as a divider.

649001-1 white -2 black -3 silver  
649001-15 pearl gold -16 brilliant blue -17 olive green

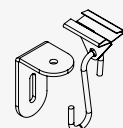

### EFFEKT CEILING PACKAGE

#### Ceiling Package

Content: S hook, angle mount for ceiling and clips for ceiling rail.

643002-1 white -2 black

## EFFEKT ECOSUND ROOM DIVIDER

Effekt is made in three standard sizes and has a thickness of 50 mm for good sound absorption. Effekt is hung in wire strings that connect and form a wall. An affordable solution that reduces a lot of sound propagation in the length of the room and parts of the room in smaller rooms. Design your unique room divider by choosing from three different core materials, six different hang wires, and a variety of colors from the Hush textile. As the design of the product may challenge for climbing and the product is not suitable for it, Effect is not recommended for school and care.





# THE HUT COLLECTION

The house's simple and straight lines are inspired by the classic game of Monopoly and its game pieces that give a timeless shape to the popular and practical "room-in-room" concept.

The house can be used for several purposes; as an individual workstation, a small sit-and-stand meeting room or as relax areas combined with The Hut Sofa. New for this year is that The Hut has a door in plexi. Everything to do it even more personally and shut out the sounds from outside and close in what is said in the house. Designed by Workspace Finland and manufactured by Gotessons. Contact us for details of the new The Hut Sofa and other Hut extras.



## THE HUT

Art.No Size/Description  
(all dimensions in mm)

**THE HUT** See price ranges on page 8-11.

**The Hut**  
110180  
**The Hut with cable channel**  
110280

Out. meas: W.1880 H.2270 D.1870  
In. meas: W.1790 H.2220 D.1790  
For all measures see [www.gotessons.com](http://www.gotessons.com).

**THE HUT WITH FRONT SCREENS**

**The Hut**  
110700  
**The Hut with cable channel**  
110800

Out. meas: W.1880 H.2270 D.1870  
In. meas: W.1790 H.2220 D.1790  
For all measures see [www.gotessons.com](http://www.gotessons.com).

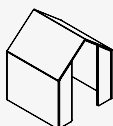
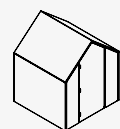
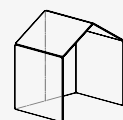

Art.No Size/Description  
(all dimensions in mm)

**THE HUT WITH FRONT SCREENS AND DOOR**

**The Hut**  
110500  
**The Hut with cable channel**  
110600

Out. meas: W.1880 H.2270 D.1870  
In. meas: W.1790 H.2220 D.1790  
For all measures see [www.gotessons.com](http://www.gotessons.com).

Info: Prices is with the same textile on both sides.  
If you want different combination of textiles, please contact us for prices.

**The Hut Lamp**  
5 m black textile cord with a copper base and black switch. LED lamp included.  
821020

**Whiteboard The Hut**  
Magnetic whiteboard for The Hut and Half a Hut.  
648110 W.1100 H.900





## THE HUT SOFA

Art.No    Size/Description  
(all dimensions in mm)



- Half a Hut Sofa**  
647130    W.860 H.1450 D.550
- Half a Hut Sofa, white Table Top**  
647131    W.860 H.1450 D.550
- Half a Hut Sofa, black Table Top**  
647133    W.860 H.1450 D.550
- Half a Hut Sofa, silver Table Top**  
647138    W.860 H.1450 D.550



- The Hut Sofa**  
647110    W.1760 H.1450 D.550
- The Hut Sofa with white Table Top**  
647111    W.1760 H.1450 D.550
- The Hut Sofa with black Table Top**  
647113    W.1760 H.1450 D.550
- The Hut Sofa with silver Table Top**  
647118    W.1760 H.1450 D.550

Note: External dimensions. Seat height: 450 mm. Seat depth: 500 mm.  
The Hut Sofa with Table Top includes 2 x 2 sockets. Table Top is a power outlet mounted in the sofa. See more information at page 140.

Textiles that can be selected for The Hut Sofa and Half A Hut Sofa, see page 8-11:

- Pricer 1: Noble Lux, Radio, Houston Reflect, Artificial Leather
- Pricer 2: Gotessons by Bogesunds
- Pricer 3: Blazer, Synergy
- Pricer 4: Remix 2

Specify the article number as follow:  
Sofa - textile colour (seam as textile)  
The Hut - textile colour (seam as textile)

## HALF A HUT

Art.No    Size/Description  
(all dimensions in mm)

**HALF A HUT** *See price ranges on page 8-11.*

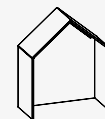

- Half a Hut**  
110400
- Half a Hut with cable channel**  
110420

Out. meas: W.1880 H.2270 D.970  
In. meas:    W.1800 H.2220 D.890  
For all measures see [www.gotessons.com](http://www.gotessons.com).

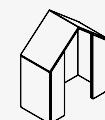

**HALF A HUT WITH FRONT SCREEN**

- Half a Hut**  
110770
- Half a Hut with cable channel**  
110880

Out. meas: W.1880 H.2270 D.970  
In. meas:    W.1800 H.2220 D.890  
For all measures see [www.gotessons.com](http://www.gotessons.com).

Art.No    Size/Description  
(all dimensions in mm)

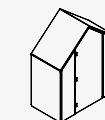

**HALF A HUT WITH FRONT SCREEN AND DOOR**

- Half a Hut**  
110550
- Half a Hut with cable channel**  
110660

Out. meas: W.1880 H.2270 D.970  
In. meas:    W.1800 H.2220 D.890  
For all measures see [www.gotessons.com](http://www.gotessons.com).

Info: Prices above is with the same textile on booth sides.  
If you want different combination of textiles, please contact us for price.





## THE HUT ROOF

Art.No    Size/Description  
(all dimensions in mm)

### THE HUT ROOF

#### The Hut Roof seam

130140	1400 x 1300
130160	1600 x 1300
130180	1800 x 1300
130200	2000 x 1300

#### The Hut Roof zip

130140	1400 x 1300
130160	1600 x 1300
130180	1800 x 1300
130200	2000 x 1300

### ORDER PROCEDURE THE HUT ROOF

1. Select screen size.
2. Select screen colour (see colour map at page 8-11).
3. Select zip or seam colour (see colours on page 11).

Facts: Mounting kit with wire ( 2 meter) and screws included. (Not screws for the roof.) The customer is responsible for the roof suitable for suspension.

#### Mount for ceiling rail

When mounting in ceiling rail. See drawings at [www.gotessons.com](http://www.gotessons.com).  
642041-1 white -2 black

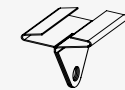
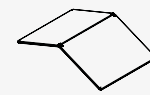

## THE HUT ROOF

The Hut Roof includes two ScreenIT A30 which are connected with a leather strap. Suspending in the air and attached via the ceiling. The sound absorbing roof creates a room within the room.



## SOFA SILENT GROUP

Art.No    Size/Description  
(all dimensions in mm)

### SOFA SILENT GROUP

#### Sofa Silent Group

647300  
W. 2200 H. 1400 D. 1700

#### Sofa Silent Group, white Table Top

647311  
W. 2200 H. 1400 D. 1700

#### Sofa Silent Group, black Table Top

647318  
W. 2200 H. 1400 D. 1700

#### Sofa Silent Group, silver Table Top

647313  
W. 2200 H. 1400 D. 1700

Note: External demensions. Seat height: 450 mm. Seat depth: 500 mm. Sofa Silent Group with Table Top includes 4 x 2 sockets.

Textiles that can be selected Sofa Silent Group:  
Pricer. 1: Noble Lux, Radio, Houston Reflect, Artificial Leather  
Pricer. 2: Gotessons of Bogesunds  
Pricer. 3: Blazer, Synergy  
Pricer. 4: Remix 2

Specify the article number as follow:  
Sofa - textile colour - zip colour (seam as zip edgings)

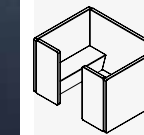

## SOFA SILENT GROUP

Sofa Silent Group forms a room within an open landscape, in the hotel lobby as well as in public areas. The group consists of 80 mm thick screen walls which makes it to a very quiet place for meetings and relaxation. Ideal to combine with The Hut Roof.







# WHITEBOARD NOTICE BOARD

Stylish and practical writing and notice boards are a must for all creative meetings. We have a variety of whiteboard solutions to offer, both those is independent of wheels, and those hanged over the screen or in our houses from The Hut Collection. Our notice boards are of good sound absorption where you either attach pictures and documents with needles, magnets or metalists.





## THE HUT WHITEBOARD

Magnetic whiteboard with painted surface to hang in the houses from The Hut Collection. Write messages directly on the board or attach paper with help of magnets. The board is easy to clean and ends with a practical pen shelf. The board is adapted to the houses from The Hut Collection.

## WHITEBOARD FOR SCREENIT A30 AND SOFAS

Magnetic whiteboard with painted surface to hang over our ScreenIT desk and floor screens. The board can also be hanged over our different sofas. Ends with a practical pen shelf. Magnets and other accessories for our screens, see page 36-38.



## WHITEBOARD FOR SCREEN

**Art.No**    **Size/Description**  
(all dimensions in mm)



### Whiteboard The Hut

Magnetic whiteboard for The Hut and Half a Hut.  
648110    W.1100 H.900

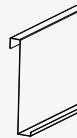

### Whiteboard for ScreenIT Standard

Magnetic whiteboard in metal.  
648105    W. 500 H. 350 D. 53    whiteb. white

### Whiteboard for ScreenIT A30

Magnetic whiteboard in metal.  
648106    W. 500 H. 350 D. 53    whiteb. white



### Whiteboard for ScreenIT A30 Floor screen

Magnetic whiteboard in metal.  
648103    W. 700 H. 900 D. 50    whiteb. white  
648104    W. 700 H. 700 D. 50    whiteb. white

## WHITEBOARD FOR FLOORSCREEN

**Art.No**    **Size/Description**  
(all dimensions in mm)

### FLOOR SCREEN

See price ranges on page 8-11.

#### A40 floor screen with seam

530180    W. 1000 H. 1800  
536180\*    W. 1600 H. 1800

#### A40 floor screen with zip

530180    W. 1000 H. 1800  
536180\*    W. 1600 H. 1800

\*Screens ordered with textiles: Noble Lux, Radio, Houston Reflect, Artificial Leather, Blazer, Synergy and Remix 2 will be with a decor seam.



### Whiteboard glass

Whiteboard in glass to mount on screen.

Suitable for screen 1000 mm.

101010    W. 990 H. 990    white

Suitable for screen 1600 mm.

101016    W. 1590 H. 990    white



### Foot set with wheels for whiteboard

Lockable wheels. 4 in one pack.

643060-1    white

643060-2    black

643060-3    silver

### Order procedure for Whiteboard:

1. Chose screen  
Specify the article number for the screen as follow:  
Screen - fabric colour - zip/seam colour.  
Ex 536180-01-101.

2. Order Whiteboard.

3. Order Foot set.

### ACCESSORIES

#### Pen shelf for whiteboard 1000 mm

Pen shelf to mount on whiteboard.

The shelf covers 966 mm of the whiteboard.

637118-1    W. 966    white

637118-2    W. 966    black

637118-3    W. 966    silver

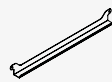

#### Pen shelf for whiteboard 1600 mm

Pen shelf to mount on whiteboard.

The shelf covers 800 mm of the whiteboard. Only space for 1 shelf.

637119-1    W. 800    white

637119-2    W. 800    black

637119-3    W. 800    silver



### Accessorie kit for whiteboard glass

Content: 4 pens, wiper and 10 magnets.

101050



## WHITEBOARD FLOORSCREEN

Stylish and practical writing board on wheels. The glass surface is made of hardened safety glass with magnetic surface, making it easy to attach both paper and write directly to the board.

The board has four rotary and lockable wheels that allow you to switch quickly from whiteboard page to a sound-absorbing bulletin board, which conveniently attaches images and documents with needles.





## STORYBOARD

Art.No    Size/Description  
(all dimensions in mm)

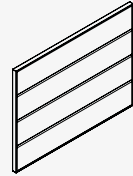

### Storyboard

125600    1600x1200

Colour frame. 1=white, 2=black

### HOW TO ORDER STORYBOARD

Art.No - Colour frame - Colour fabric.

Example: 125600-1-567 = Storyboard with white frame in blue Hush.

### Wall package Dikt for frame 1600 mm

List for wall mount.

341600    1320 mm

Facts: Can only be ordered in Hush textile.  
See textiles and frames on page 8-11.



## COLLAGE

Art.No    Size/Description  
(all dimensions in mm)

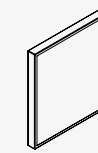

### Collage

125700    W. 600 H. 600

125701    W. 1200 H. 600

125702    W. 1200 H. 900

125703    W. 1200 H. 1200

125704    W. 1600 H. 1200

Colour frame. 1=white, 2=black

### HOW TO ORDER COLLAGE

Art.No - Colour frame - Colour fabric.

Example: 125702-1-567 = Collage with white frame in blue Hush.

### Wall package Dikt for frame

List for wall mount.

346000    320 mm

341200    920 mm

341600    1320 mm

Facts: Can only be ordered in Hush textile.  
See textiles and frames on page 8-11.

## STORYBOARD BY AM ACOUSTICS

The bulletin board for your documents. Attach documents with pins, at the metallic list or magnets. All absorbents are 50 mm thick for good sound absorption and made from our unique core material EcoSUND.

## COLLAGE

Collage is a two-in-one solution combining good acoustics with a practical notice board. Collage is manufactured in five standard formats. All absorbents are 50 mm thick for good sound absorption and made of our unique core material EcoSUND.



byAM Acoustics

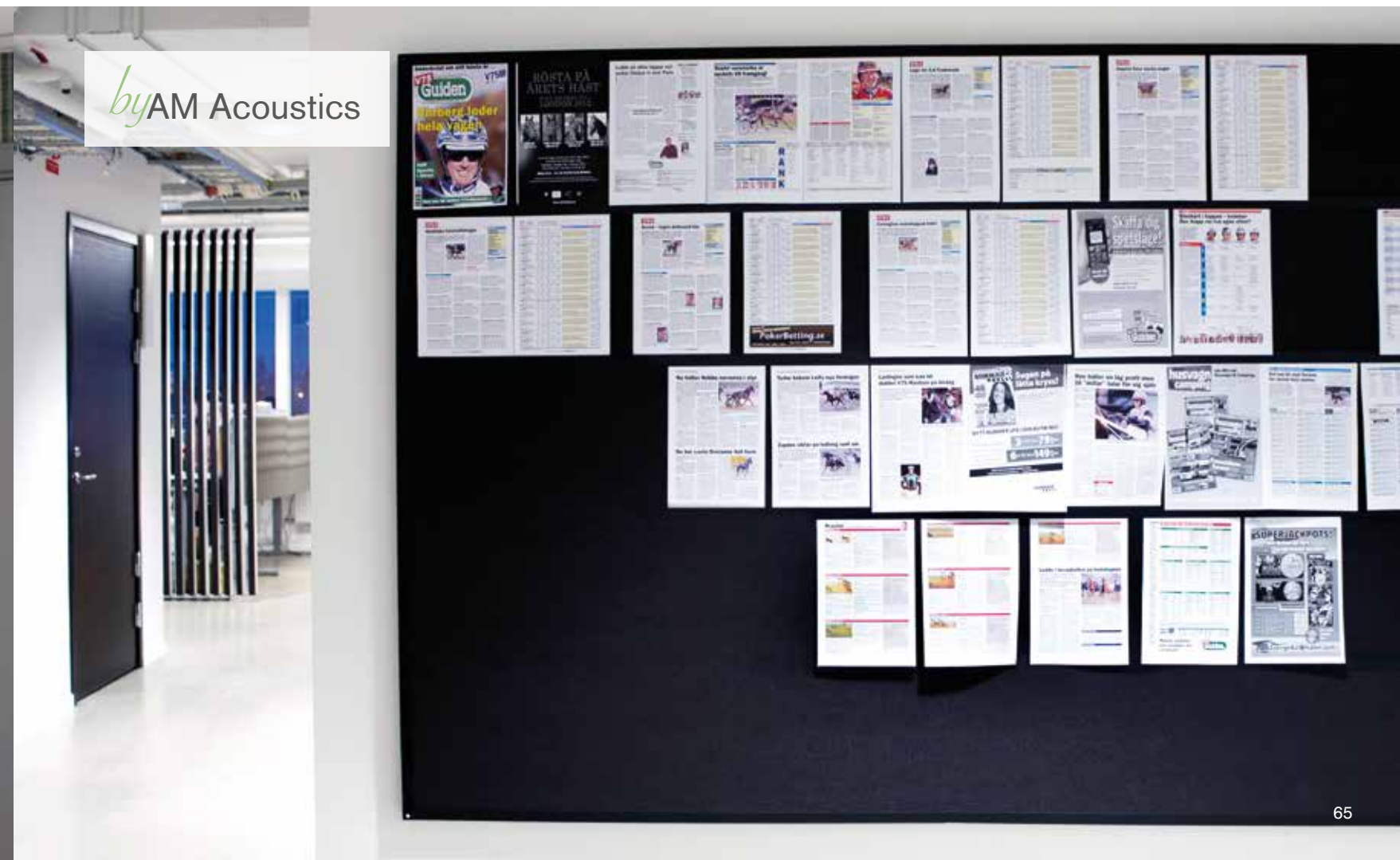

byAM Acoustics



# WALL AND CEILING ACOUSTICS

General noise pollution in open spaces is an increasing problem. The ScreenIT is an A-classed sound-absorbing wall/ceiling screen. It can also be used as a pin able bulletin or memoboard with a selection from dozens of textile colours, zips and seams.







### TELL-US ACOUSTIC WORLD MAP BY AM ACOUSTICS

Tell-Us improves the acoustics and enhances the interior design with its 3D effect. The sound absorbent is made of our unique core material EcoSUND. Tell-Us is as standard available with a black or a white frame and can be ordered with textile Hush from Gabriel. The textile is selected for its ability to allow the sound pass through to the acoustic panel to achieve maximum sound absorption.

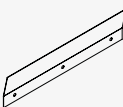

### TELL-US ACOUSTIC WORLD MAP

Art.No	Size/Description <i>(all dimensions in mm)</i>	Colour
--------	---	--------

#### Tell-Us Acoustic world map

160120 1600x1200

Colour frame. 1=white, 2=black

#### HOW TO ORDER TELL-US

Art.No - Colour frame - Colour textile - Edge colour (core).  
Example: 160120-1-567-1 = Tell-Us with white frame in blue Hush and white edge. (core).

#### Wall package Dikt for frame 1600 mm

List for wall mount.

641063 1320 mm

**Facts:** Tell-Us can only be ordered in Hush textile.  
See page 8-11 for textile and core material.

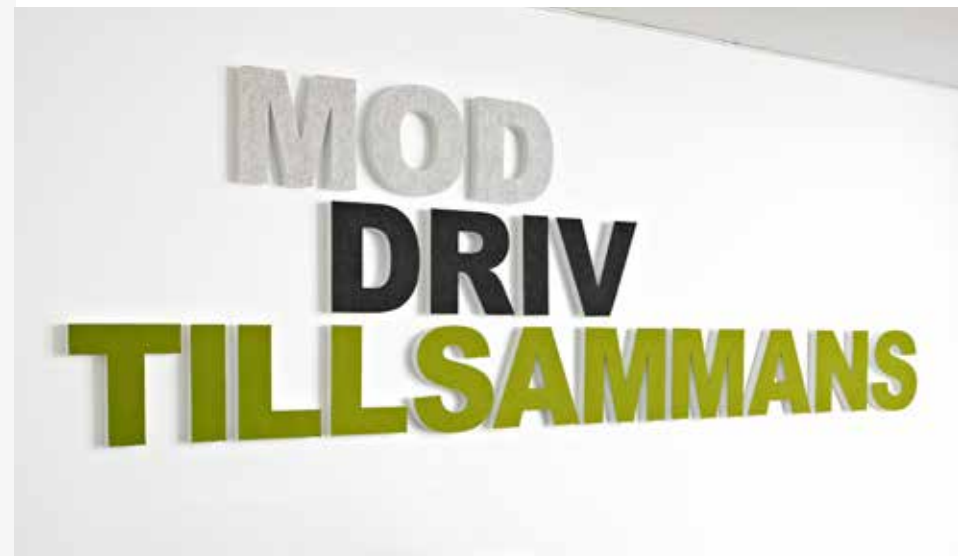

### SOUND OFF ECOSUND LETTERS

Sound absorbing 3D letters for hanging on the wall with velcro consisting of recycled polyester foam and dressed with Hush. The standard letter type is Arial Black. The standard height is 350 mm and thickness 50 mm. Contact Gotessons for more information regarding other signs and sizes, etc. Sound Off letters can only be ordered with Hush.

### SOUND OFF ECOSUND LETTERS

Art.No	Size/Description <i>(all dimensions in mm)</i>
--------	---



#### SOUND OFF ECOSUND LETTERS

Sound absorbing letters with velcro.

120110	H: 350	raw
120100	H: 350	dressed

#### Set Cost for different shapes

There is a fixed cost for orders of a different type of letters or shapes from Arial Black.  
990601

#### HOW TO ORDER LETTERS RAW:

Art.nr - Type of letter / digit / character - Colour core.  
Example: 120110-E-3 = Letter E in grey.

#### HOW TO ORDER LETTERS WITH HUSH:

Art.nr - Type of letter / digit / character - Colour of textile - Colour core.  
Example: 120100-E-569-1 = Letter E dressed with green Hush and white edge (core).

See page 8-11 for textile and core material.

byAM Acoustics



byAM Acoustics

GÖTESSONS  
akustikmiljö  
AM ACOUSTICS





### A30 SOUND ABSORBING WALL SCREEN/MEMOBOARD

All A30 screens can be used as wallscreens, absorbing excess noise and simultaneously functions as a memo board and art work. Make the wall absorber personal, choose your own image. Image suggestions are available at [www.gotessons.se](http://www.gotessons.se) or search on internet-based image banks.

### A30 WALL SCREEN WITH PRINT

Sound absorbing screen for wall. Mounted with suspension list. Make the wall absorber personal, choose your own image. Image suggestions are available at [www.gotessons.se](http://www.gotessons.se) or search on internet-based image banks.



### A30 WALL SCREEN

Art.No	Size/Description (all dimensions in mm)
--------	--

#### A30 SOUND ABSORBING MEMOBOARD

See price ranges on page 8-11.



A30 with seam		
627080	W. 800	H. 650
627120	W. 1200	H. 650
627140	W. 1400	H. 650
627160	W. 1600	H. 650
627180	W. 1800	H. 650
627200	W. 2000	H. 650



A30 with zip		
627080	W. 800	H. 650
627120	W. 1200	H. 650
627140	W. 1400	H. 650
627160	W. 1600	H. 650
627180	W. 1800	H. 650
627200	W. 2000	H. 650

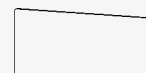

A30 with seam		
625080	W. 800	H. 800
625120	W. 1200	H. 800
625140	W. 1400	H. 800
625160	W. 1600	H. 800
625180	W. 1800	H. 800
625200	W. 2000	H. 800

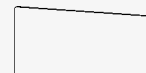

A30 with zip		
625080	W. 800	H. 800
625120	W. 1200	H. 800
625140	W. 1400	H. 800
625160	W. 1600	H. 800
625180	W. 1800	H. 800
625200	W. 2000	H. 800

#### ORDER PROCEDURE A30 SOUND ABSORBING MEMOBOARD

1. Select screen size.
2. Select screen colour (see colour map at page 8-11).
3. Select zip or seam colour (see colours on page 11).
4. Select Wall package.

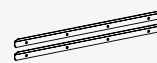

Wall package	
List for wall mount.	
641063	500 mm
641064	1000 mm (for screens longer than 1800 mm)



### SOUND OFF ECOSUND PRINT

Sound Off is available with print. Very effective and personal. Also available as extra large print. Contact our affiliate company AM Acoustics for more information about Bigprint at [www.amacoustics.com](http://www.amacoustics.com)

### SOUND OFF ECOSUND WALL

A very good sound absorber for hanging against the wall consisting of A-Classed and recycled material. Thickness 50 mm. Available in different types and sizes. Sound Off can only be ordered with Hush.

### SOUND OFF ECOSUND WALL

Art.No	Size/Description (all dimensions in mm)	Colour
--------	--	--------



#### SOUND OFF ECOSUND WALL CIRCULAR

The edge will be raw.

125384	Ø 800	raw
125385	Ø 800	dressed
125386	Ø1100	raw
125387	Ø1100	dressed
125388	Ø1400	raw
125389	Ø1400	dressed

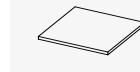

#### SOUND OFF ECOSUND WALL SQUARE

The edge will be raw.

125390	600X600	raw
125391	600X600	dressed
125392	800X800	raw
125393	800X800	dressed
125394	1000X1000	raw
125395	1000X1000	dressed

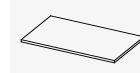

#### SOUND OFF ECOSUND WALL RECTANGULAR

The edge will be raw.

125396	600X800	raw
125397	600X800	dressed
125398	600X1000	raw
125399	600X1000	dressed
125400	600X1200	raw
125401	600X1200	dressed
125402	1000X1200	raw
125403	1000X1200	dressed

Facts: Wallmount with velcro included.

#### ORDER PROCEDURE SOUND OFF ECOSUND RAW

Art.No - Colour core.  
Example: 125390-2 = Sound Off 600x600 with black core.

#### ORDER PROCEDURE SOUND OFF ECOSUND WITH HUSH

Art.No - Colour textile - Edge colour (core/raw)  
Example: 125391-560-1 = Sound Off 600x600 in grey Hush and white edge (core/raw).

#### See page 8-11 for textile and core material.



Distances  
50 mm wall distances for Sound Off. 4 distances included.  
Screw for wall is not included.  
642057 50 mm



Tip!  
Do you want bigger print?  
Please contact Akustikmiljö,  
they are experts on this.  
[www.amacoustics.com](http://www.amacoustics.com)







### SOUND OFF ECOSUND CEILING

A very good and economical sound absorbing ceiling panel. Can be ordered with or without the LED light. Available in various styles and sizes. Made of recyclable material. Thickness 50 mm. Sound Off EcoSUND is also available laminated with Hush textile and as a wall absorber. Contact Gotessons for more information.



### SOUND OFF ECOSUND WITH PRINT

Sound Off EcoSUND can be made with print. Contact our affiliate company AM Acoustics for more information about all possibilities, see [www.amacoustics.com](http://www.amacoustics.com)



## SOUND OFF ECOSUND

Art.No	Size/Description <i>(all dimensions in mm)</i>	Colour
--------	---	--------

### SOUND OFF ECOSUND CEILING

Wire mount included. Hook for ceiling not included.  
Dressed Sound Off EcoSUND dressed on the bottom side.  
The edge will be raw.



#### Sound Off EcoSUND circular without lamps

125300	Ø 800	raw
125308	Ø 800	dressed
125310	Ø1100	raw
125311	Ø1100	dressed
125320	Ø1400	raw
125324	Ø1400	dressed

#### Sound Off EcoSUND circular with one lamp

125318	Ø 800	raw
125319	Ø 800	dressed
125312	Ø1100	raw
125313	Ø1100	dressed
125314	Ø1400	raw
125315	Ø1400	dressed

#### Sound Off EcoSUND circular with three lamps

125303	Ø 800	raw
125304	Ø 800	dressed
125305	Ø1100	raw
125306	Ø1100	dressed
125309	Ø1400	raw
125307	Ø1400	dressed

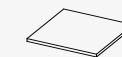

#### Sound Off EcoSUND square without lamps

125360	600x600	raw
125361	600x600	dressed
125362	800x800	raw
125364	800x800	dressed
125365	1000x1000	raw
125366	1000x1000	dressed

#### Sound Off EcoSUND square with one lamp

126350	600x600	raw
126351	600x600	dressed
126352	800x800	raw
126353	800x800	dressed
126354	1000x1000	raw
126355	1000x1000	dressed

#### Sound Off EcoSUND square with four lamps

125340	600x600	raw
125341	600x600	dressed
125342	800x800	raw
125343	800x800	dressed
125344	1000x1000	raw
125345	1000x1000	dressed

### HOW TO ORDER SOUND OFF ECOSUND RAW

Art.No - Colour core.  
Example: 125340-2 = Sound Off EcoSUND square  
600x600 with four lamps and black core.

### HOW TO ORDER SOUND OFF ECOSUND WITH HUSH

Art.No - Colour textile - Edge colour (core/raw).  
Example: 125341-567-1 = Sound Off EcoSUND square  
600x600 with four lamps, with blue Hush and white edge.  
(core/raw).

See page 8-11 for textiles and core material.



Mount for ceiling rail  
When mounting in ceiling rail. See drawings at [www.gotessons.com](http://www.gotessons.com).  
642041-1 white -2 black





byAM Acoustics

## SOUND OFF ECOSUND

Art.No Size/Description Colour  
(all dimensions in mm)

### Sound Off EcoSUND rectangular without lamps

125321	600x800	raw
125322	600x800	dressed
125323	600x1000	raw
125325	600x1000	dressed
125326	600x1200	raw
125327	600x1200	dressed
125328	1000x1200	raw
125329	1000x1200	dressed

### Sound Off EcoSUND rectangular with one lamp

125368	600x800	raw
125369	600x800	dressed
125370	600x1000	raw
125371	600x1000	dressed
125372	600x1200	raw
125373	600x1200	dressed
125374	1000x1200	raw
125375	1000x1200	dressed

### Sound Off EcoSUND rectangular with three lamps

125376	600x800	raw
125377	600x800	dressed
125378	600x1000	raw
125379	600x1000	dressed
125380	600x1200	raw
125381	600x1200	dressed
125382	1000x1200	raw
125383	1000x1200	dressed

### HOW TO ORDER SOUND OFF ECOSUND RAW

Art.No - Colour core.

Example: 125376-2 = Sound Off EcoSUND rectangular 600x800 with three lamps and black core.

### HOW TO ORDER SOUND OFF ECOSUND WITH HUSH

Art.No - Colour textile - Edge colour (core).

Example: 125377-567-1 = Sound Off EcoSUND rectangular 600x800 with three lamps, with blue Hush and white edge (core). See page 8-11 for textiles and core material.

### Mount for ceiling rail

When mounting in ceiling rail. See drawings at [www.gotessons.com](http://www.gotessons.com).  
642041-1 white -2 black

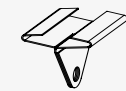

## HANG OVER

Cloud-shaped ceiling and wall panels available in two sizes. The clouds are filled with A-rated sound absorption material and foam laminated textile for a good sound absorption. Screwed to the wall or ceiling. Can also be hung from the ceiling with a wire. Suspension hooks and strap for ceiling not included.

Tip!

Combine with Hang on soft seating with identical shape. See page 90.

## HANG OVER

Art.No Size/Description  
(all dimensions in mm)

### HANG OVER

See price ranges on page 8-11.

#### Hang Over Small

678020 W. 598 H. 105



#### Hang Over Large

678030 W. 810 H. 130



### ORDER PROCEDURE HANG OVER

1. Select Hang Over size.
2. Select textile colour (see colour map at page 8-11).
3. Select zip or seam colour (see colours on page 11).
4. Select ceiling or wall mount.

### Ceiling mount for Hang Over

Loop and wire 2 m.  
642013



### Wall mount for Hang Over

Screwed to the wall.  
642012



### Mount for ceiling rail

When mounting in ceiling rail. See drawings at [www.gotessons.com](http://www.gotessons.com).  
642041-1 white -2 black



## SOUND OFF ECOSUND CEILING RECTANGULAR

A very good and economical sound absorbing ceiling panel. Can be ordered with or without the LED light. Available in various styles and sizes. Made of recyclable material. Thickness 50 mm. Sound Off EcoSUND is also available laminated with Hush textile and as a wall absorber. Contact Gotessons for more information.





## THE HUT ROOF

The Hut Roof includes two ScreenIT A30 which are connected with a leather strap. Suspending in the air and attached via the ceiling. The sound absorbing roof creates a room within the room.



## THE HUT ROOF

**Art.No**    **Size/Description**  
(all dimensions in mm)

**THE HUT ROOF**    *See price ranges on page 8-11.*

### The Hut Roof seam

130140	1400 x 1300
130160	1600 x 1300
130180	1800 x 1300
130200	2000 x 1300

### The Hut Roof zip

130140	1400 x 1300
130160	1600 x 1300
130180	1800 x 1300
130200	2000 x 1300

### ORDER PROCEDURE THE HUT ROOF

1. Select screen size.
2. Select screen colour (see textiles on page 8-11).
3. Select zip or seam colour (see textiles on page 11).

Facts: Mounting kit with wire ( 2 meter) and screws included. (Not screws for the roof.) The customer is responsible for the roof suitable for suspension.

### Mount for ceiling rail

When mounting in ceiling rail. See drawings at [www.gotessons.com](http://www.gotessons.com).  
642041-1 white -2 black

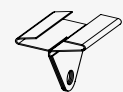

## EFFEKT ECOSUND

**Art.No**    **Size/Description**    **Colour**  
(all dimensions in mm)

### Sound Off EcoSUND rectangular without lamps

125120	1200x300x50	raw
125121	1200x300x50	dressed
125122	1200x600x50	raw
125123	1200x600x50	dressed
125124	1200x900x50	raw
125125	1200x900x50	dressed

### HOW TO ORDER EFFEKT ECOSUND RAW

Art.No - Colour core/raw.

Example: 125122-2 = Effekt EcoSUND 1200x600x50 with black core/raw.

### HOW TO ORDER EFFEKT ECOSUND WITH HUSH

Art.No - Colour textile - Edge colour (core/raw).

Example: 125123-567-1 = Effekt EcoSUND 1200x600x50 with blue Hush and white edge.(core/raw).

Facts: Effekt dressed can only be ordered in Hush textile. See textiles and core material on page 8-11.

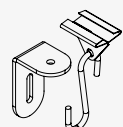
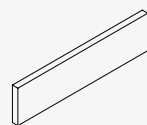

### EFFEKT HANG WIRES

Hang wire to hang Effekt EcoSund in ceiling or under ready existing Effekt.

#### Hanger 300 mm

Suitable for Effekt EcoSund 1200x300x50.

643000-1 white -2 black -3 silver  
643000-15 pearl gold -16 brilliant blue -17 olive green

#### Hanger 600 mm

Suitable for Effekt EcoSund 1200x600x50.

646000-1 white -2 black -3 silver  
646000-15 pearl gold -16 brilliant blue -17 olive green

#### Hanger 900 mm

Suitable for Effekt EcoSund 1200x900x50.

649000-1 white -2 black -3 silver  
649000-15 pearl gold -16 brilliant blue -17 olive green

### EFFEKT WIRE HOOKS

Wire hooks to get space when using Effekt EcoSund as a room divider.

#### Spice Divider 300 mm

Use to get space between Effekt EcoSund 1200x300x50 when used as a divider.

643001-1 white -2 black -3 silver  
643001-15 pearl gold -16 brilliant blue -17 olive green

#### Spice Divider 600 mm

Use to get space between Effekt EcoSund 1200x600x50 when used as a divider.

646001-1 white -2 black -3 silver  
646001-15 pearl gold -16 brilliant blue -17 olive green

#### Spice Divider 900 mm

Use to get space between Effekt EcoSund 1200x900x50 when used as a divider.

649001-1 white -2 black -3 silver  
649001-15 pearl gold -16 brilliant blue -17 olive green

### EFFEKT CEILING PACKAGE

#### Ceiling Package

Content: S hook, angle mount for ceiling and clips for ceiling rail.  
643002-1 white -2 black

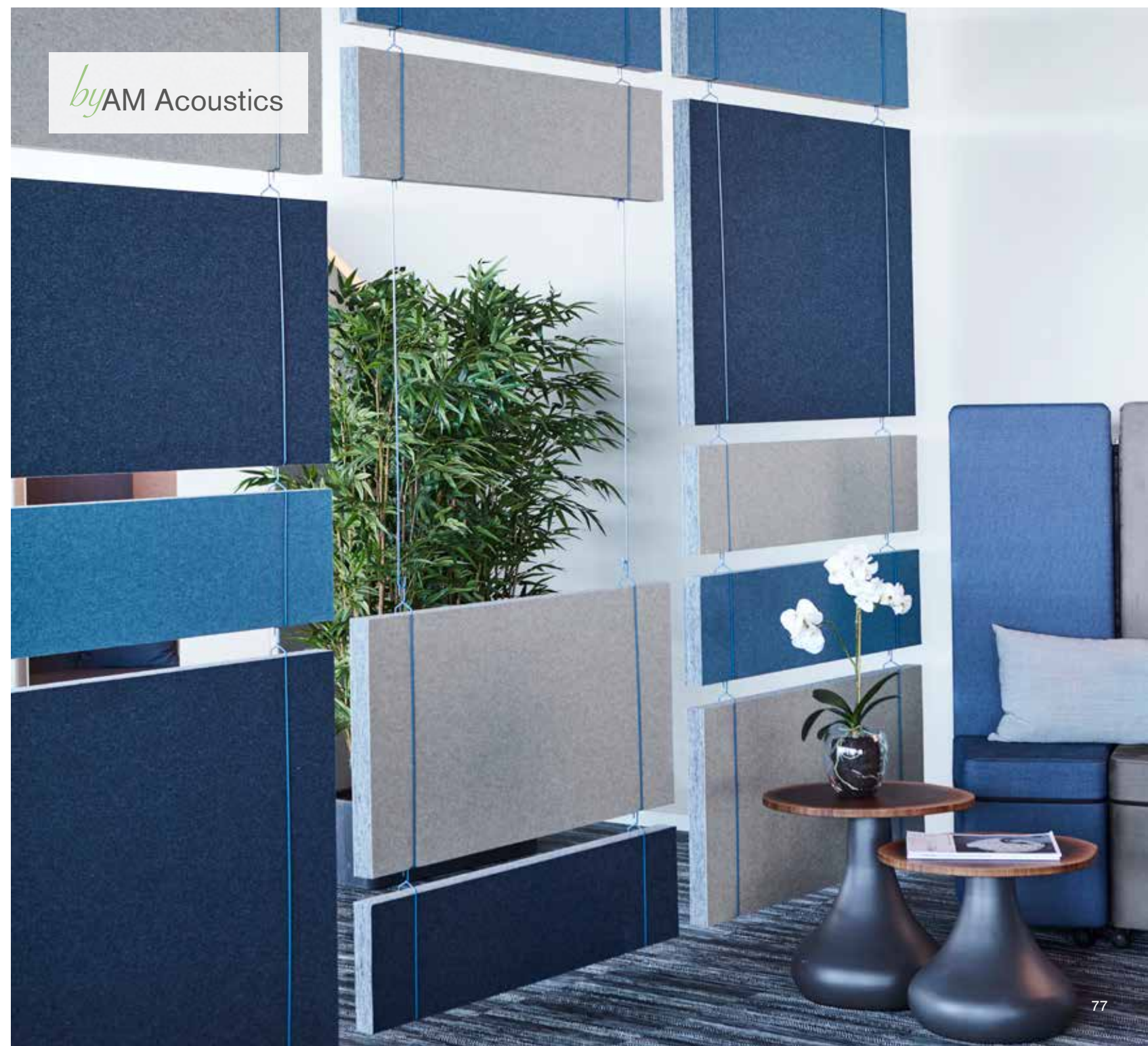

## EFFEKT ECOSUND CEILING

An effective way to improve the acoustics of a room without having to change existing installations such as ventilation, cables, lights, etc. is to mount Effekt ceiling absorbers. With even distribution based on the needs of the local area, it becomes an affordable solution that reduces a lot of audio spread in the longitudinal direction of the room. Customize your absorbers by choosing from three core materials and laminate them with the Hush textile, available in several different colors.

## EFFEKT ECOSUND ROOM DIVIDER

Effekt is made in three standard sizes and has a thickness of 50 mm for good sound absorption. Effekt is hanged in wire strings that connect and form a wall. An affordable solution that reduces a lot of sound propagation in the length of the room and parts of the room in smaller rooms. Design your unique room divider by choosing from three different core materials, six different hang wires, and a variety of colors from the Hush textile. As the design of the product may challenge for climbing and the product is not suitable for that, Effekt is not recommended for school and care.





## NIVÅ ECOSUND SOUND ABSORBING WALL PANEL

Nivå improves acoustics and its design makes it a feature in any room. The panels can be varied to form different patterns in different colours, with or without textile. Nivå is made of our unique core material EcoSUND. Our core material is available in three colors, and with the possibility of laminating with several different textiles, your wall becomes almost unique.

The thickness of the absorber varies over the surface from 30 to 80 mm in the cut rectangular and square patterns.

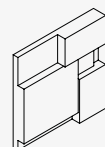

## NIVÅ WALL PANEL

Art.No	Size/Description (all dimensions in mm)	Colour
<b>Nivå Wall panel</b>		
125593	593x593	raw
125594	593x593	dressed

### HOW TO ORDER NIVÅ ECOSUND RAW

Art.No - Colour core.  
Example: 125593-2 = Nivå EcoSUND with black core.

### HOW TO ORDER NIVÅ ECOSUND WITH HUSH

Art.No - Colour textile - Edge colour (core).  
Example: 125594-567-1 = Nivå EcoSUND with blue Hush and white edge (core).

Facts: Nivå dressed can only be ordered in Hush textile.  
See textiles and core material on page 8-11.



## NIVÅ ECOSUND SOUND ABSORBING CEILING PANEL

Nivå improves acoustics and its design makes it a feature in any room. The panels can be varied to form different patterns in different colours, with or without textile. Nivå is made of our unique core material EcoSUND. Our core material is available in three colors, and with the possibility of laminating with several different textiles, your ceiling becomes almost unique.

Nivå is manufactured in dimensions of 593 x 593 mm in two versions, one to work as a wall panel sound absorbent, the other to fit grid systems for ceilings (edge A). Thickness varies across the surface from 30-80 mm.

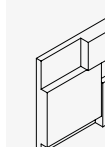

## NIVÅ CEILING PANEL

Art.No	Size/Description (all dimensions in mm)	Colour
<b>Nivå Ceiling panel</b>		
125595	593x593	raw
125596	593x593	dressed

### HOW TO ORDER NIVÅ ECOSUND RAW

Art.No - Colour core.  
Example: 125595-2 = Nivå EcoSUND with black core.

### HOW TO ORDER NIVÅ ECOSUND WITH HUSH

Art.No - Colour textile - Edge colour (core).  
Example: 125596-567-1 = Nivå EcoSUND with blue Hush and white edge (core).

Facts: Nivå dressed can only be ordered in Hush textile.  
See textiles and core material on page 8-11.

byAM Acoustics

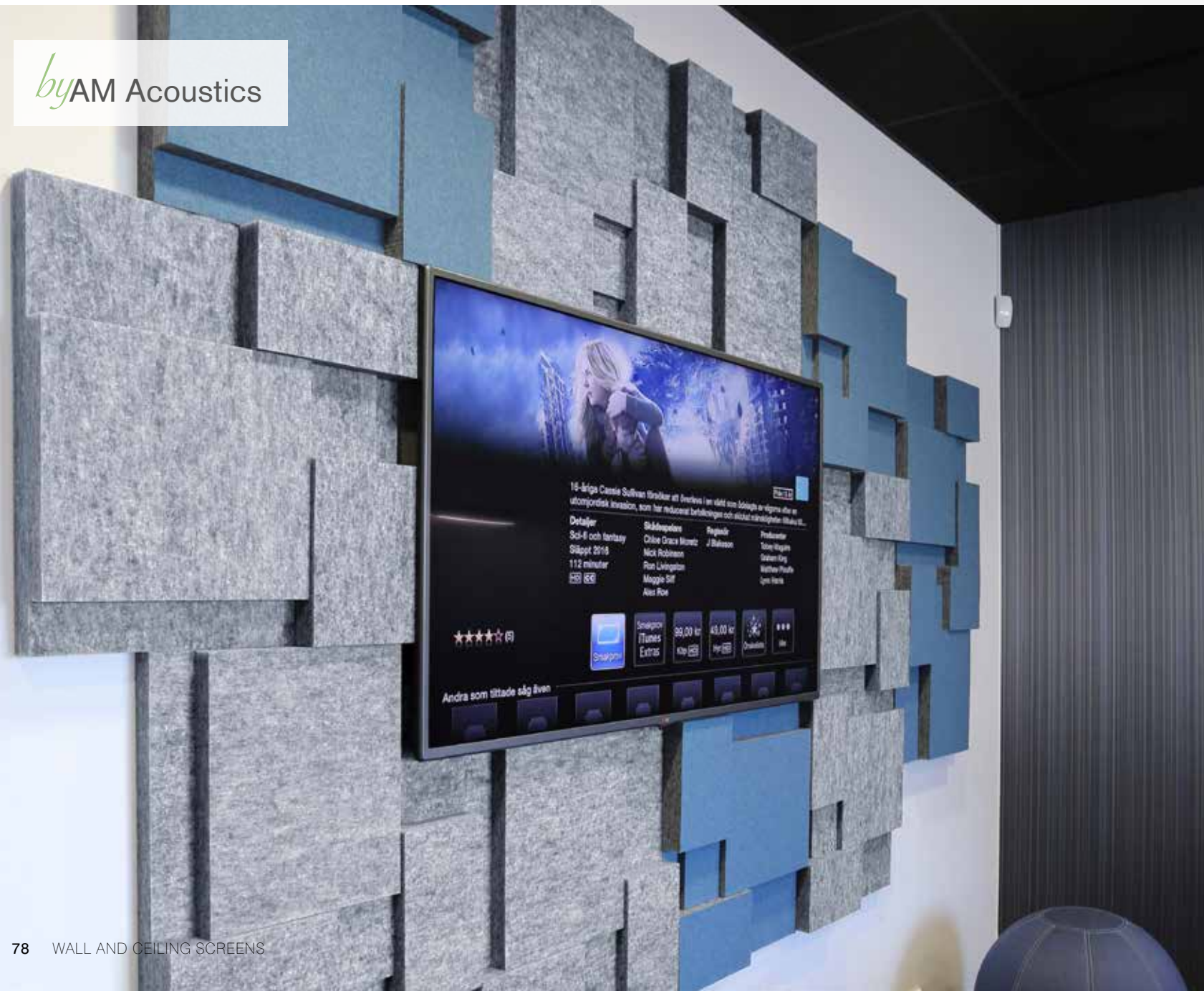

byAM Acoustics

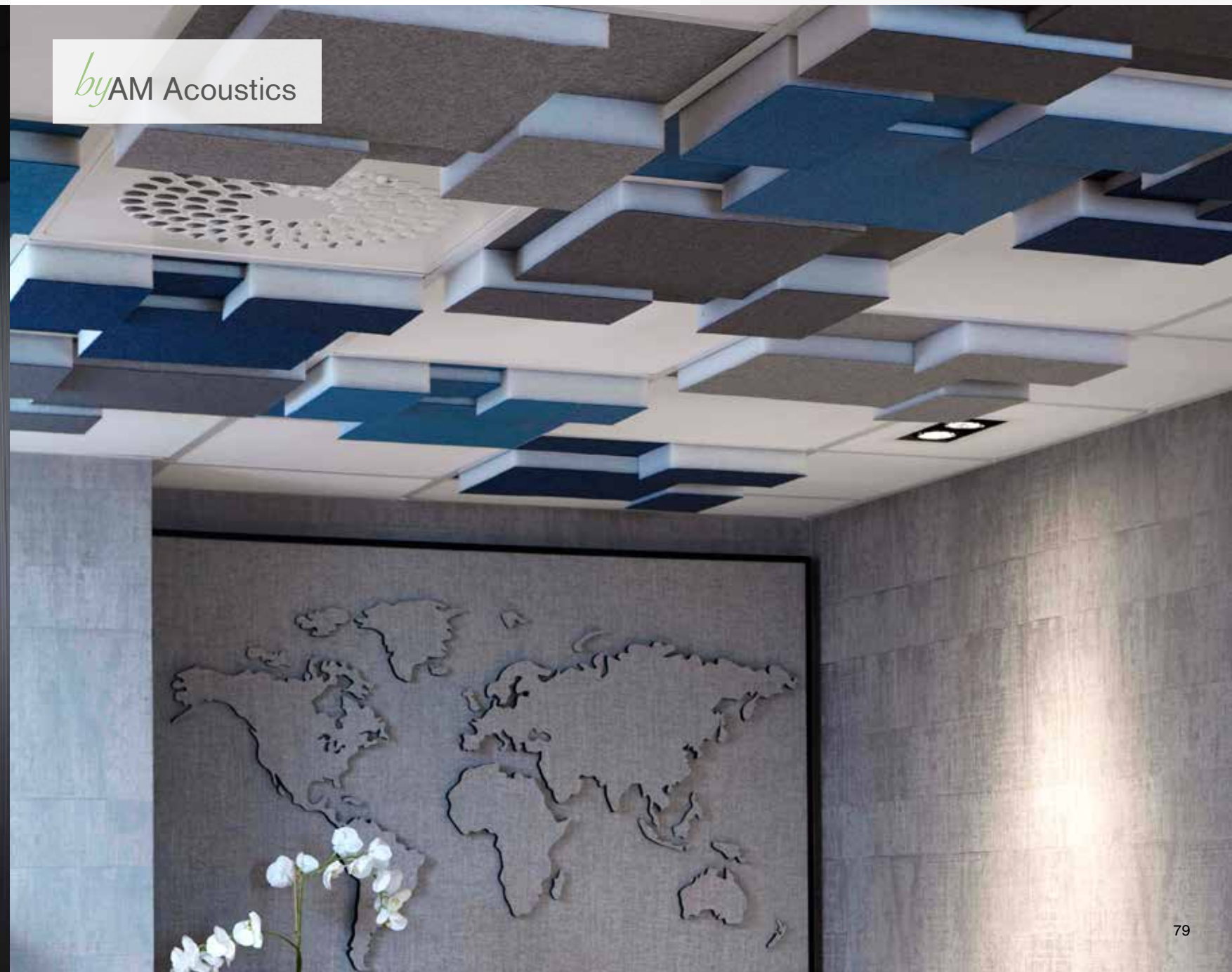





## HONEY ECOSUND WALL PANEL SOUND ABSORBENT

Honey is a playful and modular wall panel that can be varied to form different patterns in different colours, with or without textile. Honey is available in three thicknesses — 20 mm, 40 mm and 50 mm. All panels have good sound absorbing properties. Honey is manufactured with a straight edge and comes with velour backing for easy mounting with Velcro. The sound absorbent is made from our unique core material EcoSUND. Our core material is available in three colors and with the ability to dress textiles in several colors your wall becomes almost unique.

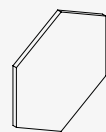

## HONEY WALL PANEL

Art.No	Size/Description <i>(all dimensions in mm)</i>	Colour
<b>Honey Wall panel</b>		
125520	600x520x20	raw
125521	600x520x20	dressed
125522	600x520x40	raw
125523	600x520x40	dressed
125524	600x520x50	raw
125525	600x520x50	dressed

### HOW TO ORDER HONEY ECOSUND RAW

Art.No - Colour core.  
Example: 125520-2 = Honey EcoSUND 600x520x20 with black core.

### HOW TO ORDER HONEY ECOSUND WITH HUSH

Art.No - Colour textile - Edge colour (core).  
Example: 125521-567-1 = Honey EcoSUND 600x520x20 with blue Hush and white edge. (core).

Facts: Honey dressed can only be ordered in Hush textile.  
See textiles and core material on page 8-11.



## COLLAGE/STORYBOARD

Art.No	Size/Description <i>(all dimensions in mm)</i>
--------	---



### COLLAGE

125700	W. 600 H. 600
125701	W. 1200 H. 600
125702	W. 1200 H. 900
125703	W. 1200 H. 1200
125704	W. 1600 H. 1200

Colour frame. 1=white, 2=black

### HOW TO ORDER COLLAGE

Art.No - Colour frame - Colour textile.  
Example: 125702-1-567 = Collage with white frame in blue Hush.

### Wall package Dikt for frame

List for wall mount.

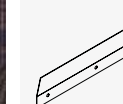

346000	320 mm	(to Collage 600 mm)
349000	620 mm	(to Collage 900 mm)
341200	920 mm	(to Collage 1200 mm)
341600	1320 mm	(to Collage 1600 mm)

Facts: Can only be ordered in Hush textile.  
See textiles and frames on page 8-11.



### STORYBOARD

125600	1600x1200
--------	-----------

Colour frame. 1=white, 2=black

### HOW TO ORDER STORYBOARD

Art.No - Colour frame - Colour textile.  
Example: 125600-1-567 = Storyboard with white frame in blue Hush.



### Wall package Dikt for frame 1600 mm

List for wall mount.

341600	1320 mm
--------	---------

Facts: Can only be ordered in Hush textile.  
See textiles and frames on page 8-11.

## COLLAGE ECOSUND

Collage is a two-in-one solution combining good acoustics with a practical notice board. Collage is manufactured in five standard formats. All absorbents are 50 mm thick for good sound absorption and are made of our unique core material EcoSUND.

## STORYBOARD ECOSUND

The bulletin board for your documents. Attach documents with pins or magnets. All absorbents are 50 mm thick for good sound absorption and are made from our unique core material EcoSUND.



byAM Acoustics



byAM Acoustics





ULRICEHAMN  
SHOWROOM



FALKENBERG  
SHOWROOM



MALMÖ  
SHOWROOM



STOCKHOLM  
SHOWROOM



# SOFT SEATING

Soft seating stools at the office that acts as an extra seat for visitors and private storage. Comfortable sofas with high backrest creating a sheltered privacy, a place to meet or retreat. Soft lounge furniture for a short nap to quickly get some new energy for the next meeting. Seatings for all kind of environments where you can design and build your own creative space.







## OFFICE BALLZ

Art.No    Size/Description  
(all dimensions in mm)

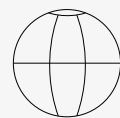

### OFFICE BALLZ

Delivered with a pump.      See price ranges on page 8-11.

**Office Ball Big**  
640065    Ø 650

**Office Ball Small**  
640055    Ø 550

Textiles that can be selected for the Office Ballz, se page 8-11:

Pricer. 1: Noble Lux, Radio, Houston Reflect, Artificial Leather

Pricer. 2: Gotessons by Bogesunds

Pricer. 3: Blazer, Synergy

Pricer. 4: Remix 2

Specify the article number as follow:

Office Ballz - textile colour - zip colour.

Not available with fishbone zip.



**OFFICE BALLZ**

A fun and great seating furniture for the office that strengthens muscle groups in your back and legs and keep them active while you work. The Office Ballz is available in two sizes in a large variation of textile and zippers so it is easy to match it with other furnishings in the office. You regulate the inner ball easily with the included pump and the bottom is reinforced which makes it stable.





## OFFICE NAP

Art.No	Size/Description <i>(all dimensions in mm)</i>	Colour
--------	---	--------

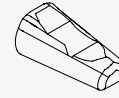

**OFFICE NAP**  
*Inner bag covered with textile of your choice.*  
*See price ranges on page 8-11.*

**OFFICE NAP**  
 640075 W. 700 H. 600  
 D. 1400

Textiles that can be selected for the Office Nap, see page 8-11:  
 Pricer 1: Noble Lux, Radio, Houston Reflect, Artificial Leather  
 Pricer 2: Gotessons by Bogesunds  
 Pricer 3: Blazer, Synergy  
 Pricer 4: Remix 2

Specify the article number as follow:  
 Office Nap - textile colour - zip colour.  
 Seam as zip edgings.  
 Not available with fishbone zip.

## OFFICE NAP

A soft seating furniture for the short nap to quickly get energy for the next meeting. Ideal for creative meetings in the activity-based landscape. A short nap during working hours can enhance performance and job satisfaction. Office Nap is designed and manufactured in Sweden to fit the office environment and is made of eco-friendly materials. It is also great to sit in an upright position, if for some reason there is no time for a nap!







## HANG ON/SMS-BOX

Art.No Size/Description  
(all dimensions in mm)

**HANG ON** See price ranges on page 8-11.

**Hang On Big**  
647060 W. 830 H. 600

**Hang On Medium**  
647080 W. 830 H. 500

**Hang On Small**  
647070 W. 730 H. 400

**Hang On Kid**  
647090 W. 730 H. 200



**SMS-BOX** See price ranges on page 8-11.

**SMS-Box**  
Stool, on wheels with storage  
647020 W. 370 H. 500  
D. 370

Stool, no wheels with storage  
647050 W. 370 H. 500  
D. 370



Textiles that can be selected for Hang On/SMS-Box, see page 8-11:  
Pricer 1: Noble Lux, Radio, Houston Reflect, Artificial Leather  
Pricer 2: Gotessons by Bogesunds  
Pricer 3: Blazer, Synergy  
Pricer 4: Remix 2

Specify the article number as follow:  
Hang On/SMS-Box - textile colour - zip colour.  
Seam as zip edgings.

## HANG ON

A sleek and modern seating furniture to create more diverse environments. The product is also a very good sound absorber. Hang On is available in four different heights and with a wide range of textiles and zippers.



## CONNECTING SEAT

Art.No Size/Description  
(all dimensions in mm)

**CONNECTING SEAT** See price ranges on page 8-11.

**Connecting Seat**

Stool, on wheels, single.  
647800 W. 450 H. 1450  
D. 450

Stool, on wheels, middle.  
647810 W. 450 H. 1450  
D. 450

Stool, on wheels, right.  
647820 W. 450 H. 1450  
D. 450

Stool, on wheels, left.  
647830 W. 450 H. 1450  
D. 450

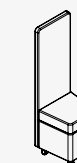

Textiles that can be selected for the stool, see page 8-11:  
Pricer 1: Noble Lux, Radio, Houston Reflect, Artificial Leather  
Pricer 2: Gotessons by Bogesunds  
Pricer 3: Blazer, Synergy  
Pricer 4: Remix 2

Specify the article number as follow:  
Stool - textile colour - zip colour.  
Seam as zip edgings.



## SMS-BOX Sit - Meet - Store

Soft seating box with lid for storage. Fits perfect under the desk. The SMS box is available in a large variation of textile and zippers so it is easy to match it with other furnishings in the office.

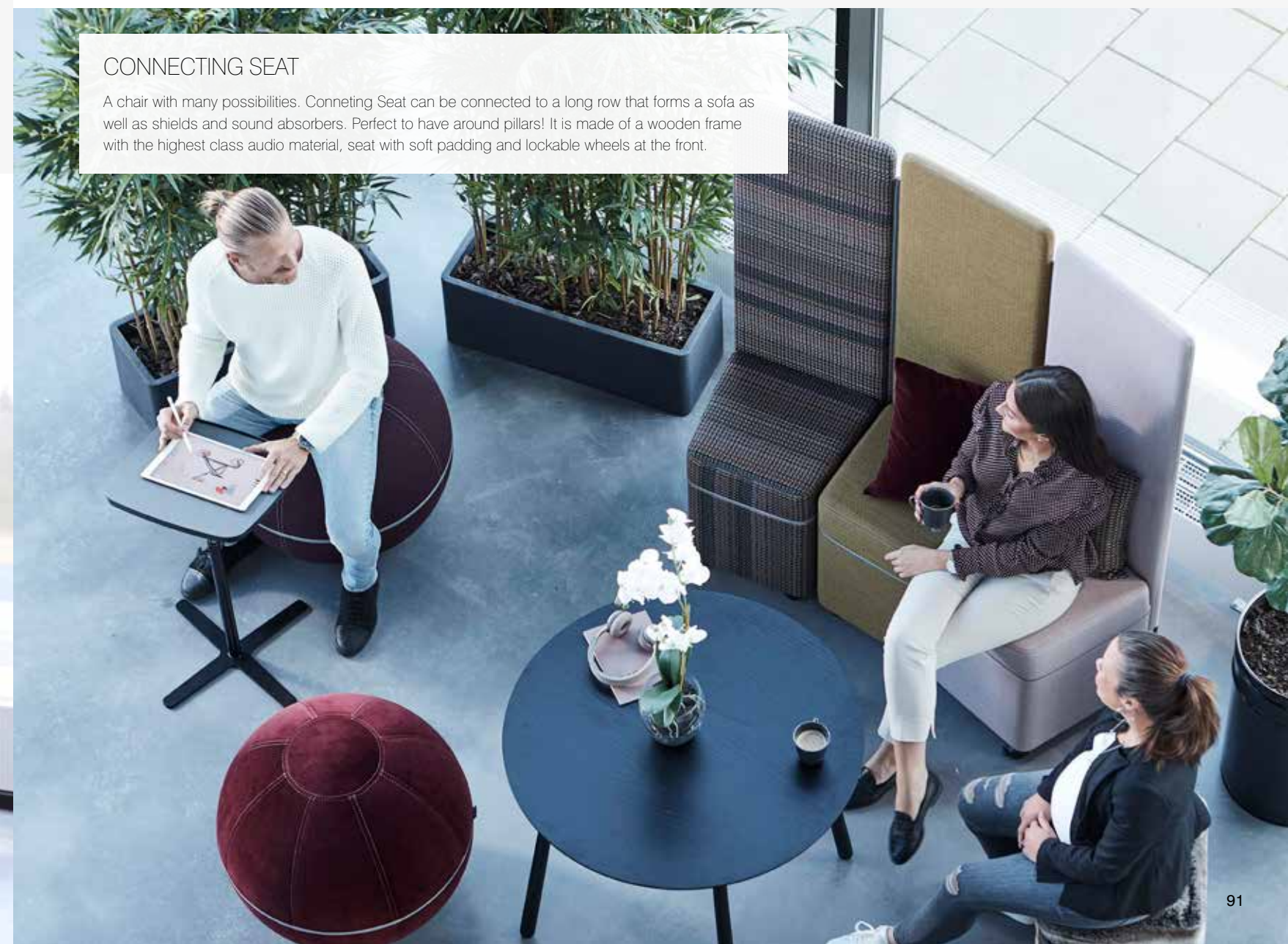

## CONNECTING SEAT

A chair with many possibilities. Connecting Seat can be connected to a long row that forms a sofa as well as shields and sound absorbers. Perfect to have around pillars! It is made of a wooden frame with the highest class audio material, seat with soft padding and lockable wheels at the front.





## SOFA SOUND BOOTH

The Sofa Sound Booth is a leanback sofa designed in the ScreenIT style. Combining comfortable seating with high backrest creating a sheltered privacy, a place to meet or retreat. Two sofas opposite each other forms a room within an open landscape, ideal for hotel lobby's as well as office environments. The Sofa Sound Booth can also be delivered with 2 pcs of Table Top 2 extensions.

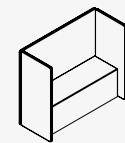

## SOFA SOUND BOOTH

Art.No Size/Description  
(all dimensions in mm)

### SOFA SOUND BOOTH

See price ranges on page 8-11.

#### Sofa Sound Booth

647100

#### Sofa Sound Booth with white Table Top

647301

#### Sofa Sound Booth with black Table Top

647308

#### Sofa Sound Booth with silver Table Top

647303

Note: External demensions: W. 1700 H. 1400 D. 700. Inner: W: 1620 D: 660. Seat height: 450 mm. Seat depth: 500 mm. Sofa Sound Booth with Table Top includes 2 x 2 sockets. Table Top is a power outlet mounted in the sofa. See more information at page 140.

Textiles that can be selected for the Sofa Sound Booth, see page 8-11:

Pricer. 1: Noble Lux , Radio, Houston Reflect, Artificial Leather

Pricer. 2: Gotessons by Bogesunds

Pricer. 3: Blazer, Synergy

Pricer. 4: Remix 2

Specify the article number as follow:

Sofa - textile colour - zip colour (seam as zip edgings)

### SOFA SOUND CUSHIONS

Also available with screenprint, contact us for more information.

#### Sofa Sound Cushion Big

657100 W. 760 H. 450

#### Sofa Sound Cushion Small

657110 W. 450 H. 450

Specify the article number as follow:

Cushion - textile colour (seam as textile colour)

For information about BringIT Storage Bag, see page 124.



## PAZ SOFA

Art.No Size/Description  
(all dimensions in mm)

### PAZ SOFA

See price ranges on page 8-11.

#### PAZ Sofa

105300

#### PAZ Sofa with white Table Top

105301

#### PAZ Sofa with black Table Top

105308

#### PAZ Sofa with silver Table Top

105303

Note: External demensions: W. 1700 H. 1400 D. 700. Seat height: 450 mm. Seat depth: 500 mm. Inner: W: 1620 mm D: 660 mm. Sofa Sound Booth with Table Top includes 2 x 2 sockets.

Textiles that can be selected for the PAZ Sofa, see page 8-11:

Pricer. 1: Noble Lux, Radio, Houston Reflect, Artificial Leather

Pricer. 2: Gotessons by Bogesunds

Pricer. 3: Blazer, Synergy

Pricer. 4: Remix 2

Specify the article number as follow:

Sofa - textile colour sofa - zip colour - textile colour aircleaner

(seam as zip edgings)

Note! The textile in front of the filter must be from Harlequin or Runner.

### Replacement filter

Needs to be renewed every second year.

105119

### TECHNICAL DATA:

Type of filter: Front filter+ Fine filter F9 (EN 779: 2012)

Air Flow: LOW/MEDIUM/BOOST 40/50/240 m3/h ±10

Equivalent Air Flow: LOW/MEDIUM/BOOST 38/47.5/228 m3/h ±10

Noise Level: LOW/MEDIUM/BOOST 28/32/47 dB(A)

Energy consumption: LOW/MEDIUM/BOOST 25/31/68 W

For more information see [www.gotessons.com](http://www.gotessons.com).



## PAZ SOFA

A unique sofa that enhances your productivity and health. PAZ stands for Pure Air Zone. PAZ combines the functions of sound absorption and air purification in a patented design. Creates a bubble of clean air through the upper back of the sofa. Draught-free. Mute. Energy-efficient. The sofa is basically a Sofa Sound Booth, see prevois page. Comes complete with filters. Can also be delivered with 2 pcs of Table Top 2 extensions. Choose the textile in front of the filter from Harlequin or Runner.

### HARLEQUIN



Colour:500 (64081 Red) Colour:501 (63053 Orange) Colour:502 (66118 Purple) Colour:504 (61152 Dark grey) Colour:505 (60999 Black) Colour:506 (68095 Green)

### RUNNER

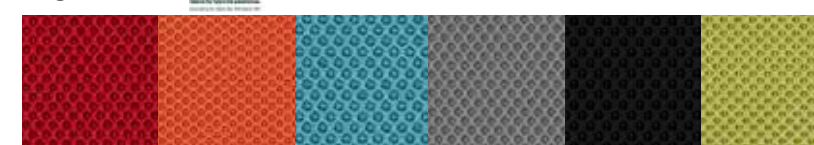

Colour:520 (64089 Red) Colour:521 (63034 Orange) Colour:522 (66063 Light blue) Colour:523 (60011 Light grey) Colour:525 (60999 Black) Colour:526 (68056 Green)

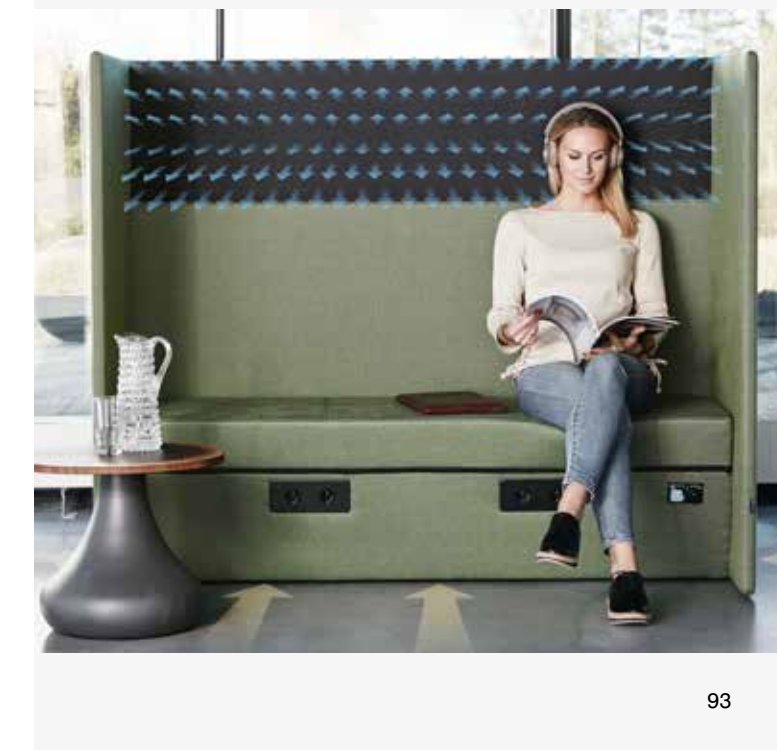



# ERGONOMICAL PRODUCTS, MATS, FLOOR PROTECTION

Protect everything from top to bottom! Ergonomical products, smart foot and wrist support that make sure you are in the right position when you work. A variety of types of removable carpets and floor coverings to prevent unnecessary wear.







## YOGA MAT STANDZON

Art.No	Size/Description <i>(all dimensions in mm)</i>	Colour
--------	---	--------



### Anti-fatigue Yoga mat StandzOn

Soft ergonomic mat with cork or textile-clad surface. The core is made of absorbent and silencing material polyurethane. Thickness 18 mm.

180004	980x520 mm	red
180005	980x520 mm	grey
180006	980x520 mm	cork

## YOGA MAT STANDZON

Yoga is an ergonomically designed anti-fatigue mat that is ideal for standing work. It is a workplace mat made in the absorbent and sound-absorbing polyurethane material. The carpet is available in two different sizes and features a handle that allows it to be easily hung on your screen when not in use. Fits hanging on the ScreenIT A30 hook, see page 39. By standing up and work, you can prevent some diseases, get a better posture and higher well being. Why not use Yoga mat to do simple yoga or gymnastics exercises at lunch?



## ANTI-FATIGUE MAT WAVE STANDZON

Wave is a soft ergonomic mat with massage properties. The carpet is made of polyurethane soundproofing material. The carpet is available in two different sizes and features a handle that allows it to be easily hung on your screen when not in use. Fits hanging on the ScreenIT A30 hook, see page 39.

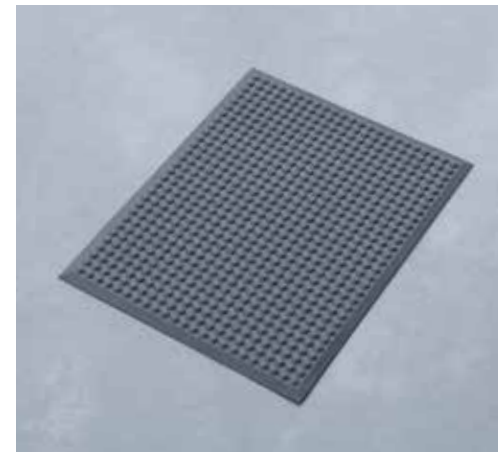

## ANTI-FATIGUE MAT BUBBLE STANDZON

Ergonomic shaped mat with massage function, suits your sit and stand desk. The carpet is made of polyurethane soundproofing material and comes in two sizes.

## ERGONOMICAL MAT

Art.No	Size/Description <i>(all dimensions in mm)</i>	Colour
--------	---	--------



### Anti-fatigue mat Wave StandzOn

Ergonomic soft mat with massage function. Thickness 14 mm.

180007	950x650 mm	black
180008	660x500 mm	black

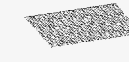

### Anti-fatigue mat Bubble StandzOn

Ergonomic soft mat with massage function. Thickness 14 mm.

180000	640x480 mm	dark grey
180001	600x900 mm	dark grey

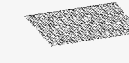

### Anti-fatigue mat StandzOn

Ergonomic soft mat produced in polyurethane. Thickness 15 mm.

180003	770x510 mm	black
--------	------------	-------

## ANTI-FATIGUE STANDZON

Ergonomically designed mat ideal for standing work. StandzOn is a soft mat produced in polyurethane which is sound absorbing and relieving.

By standing up and work, you can prevent some diseases, get a better posture and higher well being.







## FLOOR PROTECTION PET

100 % recyclable transparent floor protection mat (PET). To protect the floor and for better chair movement on carpets etc.



## FLOOR PROTECTION STANDARD

The floor cover is designed for both hard and soft floors and has a smooth underside that ensures that the cover is firmly on the floor. The protection is rectangular with rounded corners. Made of high quality transparent polyvinyl.



## FOOT SUPPORT

The foot support is angled and adjustable with pressure from the foot. It has a powerful construction and the upper side are covered with a durable rubber mat.

## FLOOR PROTECTION

Art.No Size/Description Colour  
(all dimensions in mm)

### Floor Protection PET (for plain covered floors)

Produced in 100% recyclable PET material.  
132750 900x1200 mm  
132760 1200x1500 mm  
132780 1200x1800 mm

### Floor Protection PET (for carpet covered floors)

Produced in 100% recyclable PET material.  
130750 900x1200 mm  
130760 1200x1500 mm  
130770 1200x1800 mm

### Floor Protection Standard (for plain floors)

Rectangular transparent floor protection made of high quality polyvinyl, thickness 3 mm, delivery of 1 piece in cardboard packaging.

233030 1200x1000 mm  
233040 1200x1500 mm  
233050 1200x2000 mm

### Floor Protection Standard (for carpet covered floors)

Rectangular transparent floor protection made of high quality polyvinyl, thickness 3 mm, delivery of 1 piece in cardboard packaging.

233000 1200x1000 mm  
233010 1200x1500 mm  
233020 1200x2000 mm

### Combined Floor Protection sit and stand

Combined transparent floor protection/ergonomic mat for desks that can be raised and lowered. Thickness 4 + 9 mm. Suits both plain floors and carpet covered floors.

232010 910x1220 mm  
232020 1520x1220 mm

### Foot support

Strong bended metal tube, 16 mm rubber covered wooden plate.  
125001 L. 530 W. 360 H. 125 black

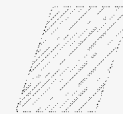

## ARM REST / WRIST SUPPORT

Art.No Size/Description Colour  
(all dimensions in mm)

### Simple Rest

Traditional arm rest. Holders can be adjusted for round desks. Covered with Lycra fabric.

122006 L. 670 H. 25 D. 230 black



### Asymmetrical arm rest + mouse pad Value pack

Asymmetrical arm rest, filled with cellular polyethylene, covered with leatherette. Removable attachment arm. Bottomplate made from 4 mm sheet-metal.

122020 (122010 + 122011) black

### Asymmetrical arm rest

122010 L. 670 H. 21 D. 258 black



### Asymmetrical mouse pad

Formed mouse pad made to fit the Asymmetrical arm rest above, can be used on both sides (left and right hand). Filled with cellular polyethylene, covered with leatherette.

122011 black



## SIMPLE REST

Traditional armrest with great support and depth. Covered with strong Lycrafabric.



## ASYMMETRICAL ARM REST

Always have your keyboard directly in front of you. Movable mouse pad for working with both left and right hand.

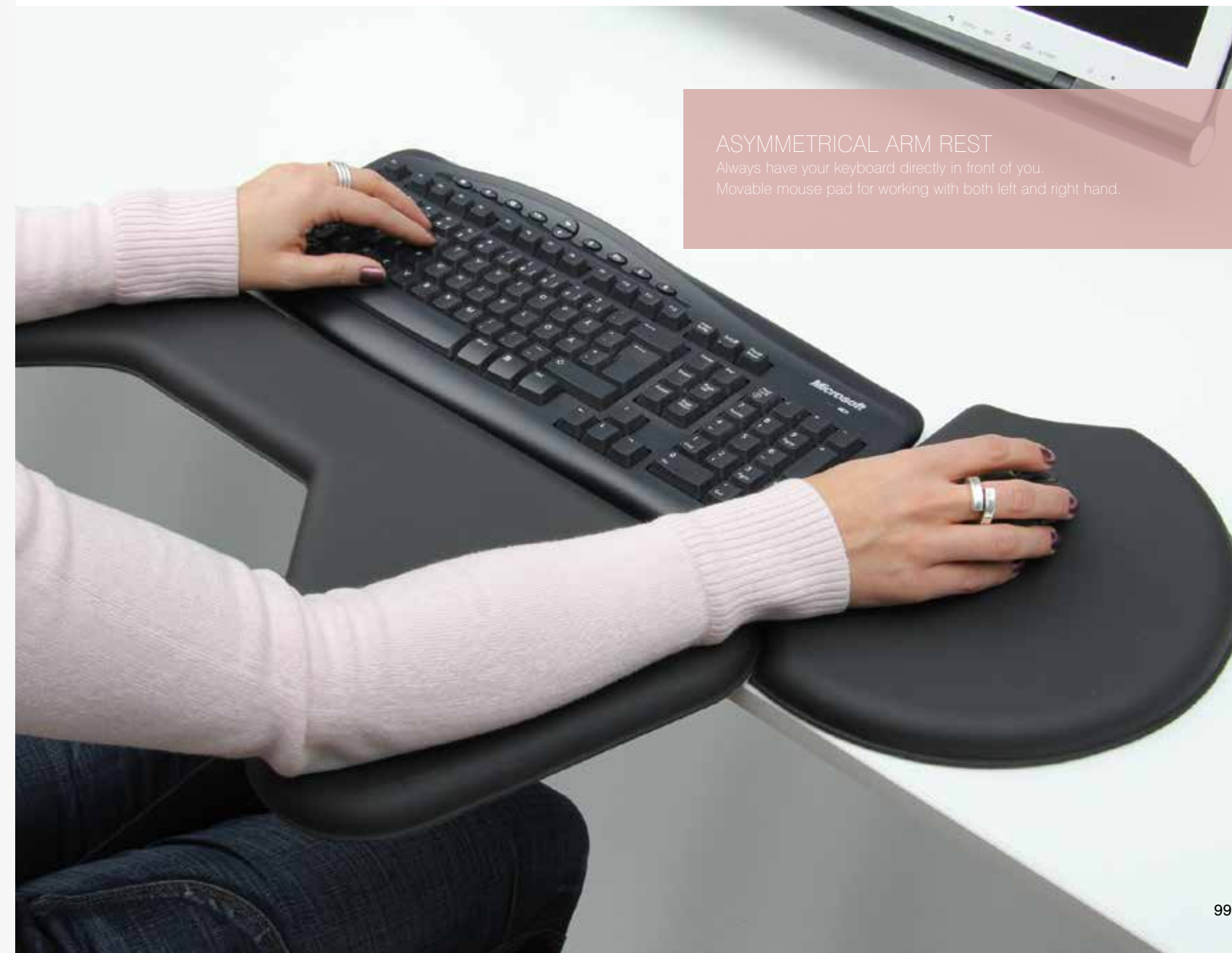



# ARTIFICIAL PLANTS

High-quality artificial plants for decoration of office, conference and hotels. Our plants are lifelike and requires minimal maintenance. An economical alternative when no contractual maintenance is required and obviously no allergy risks! Combined with our trendy oil drums it can be used as a divider between spaces in the office and at the same time create a green oasis.

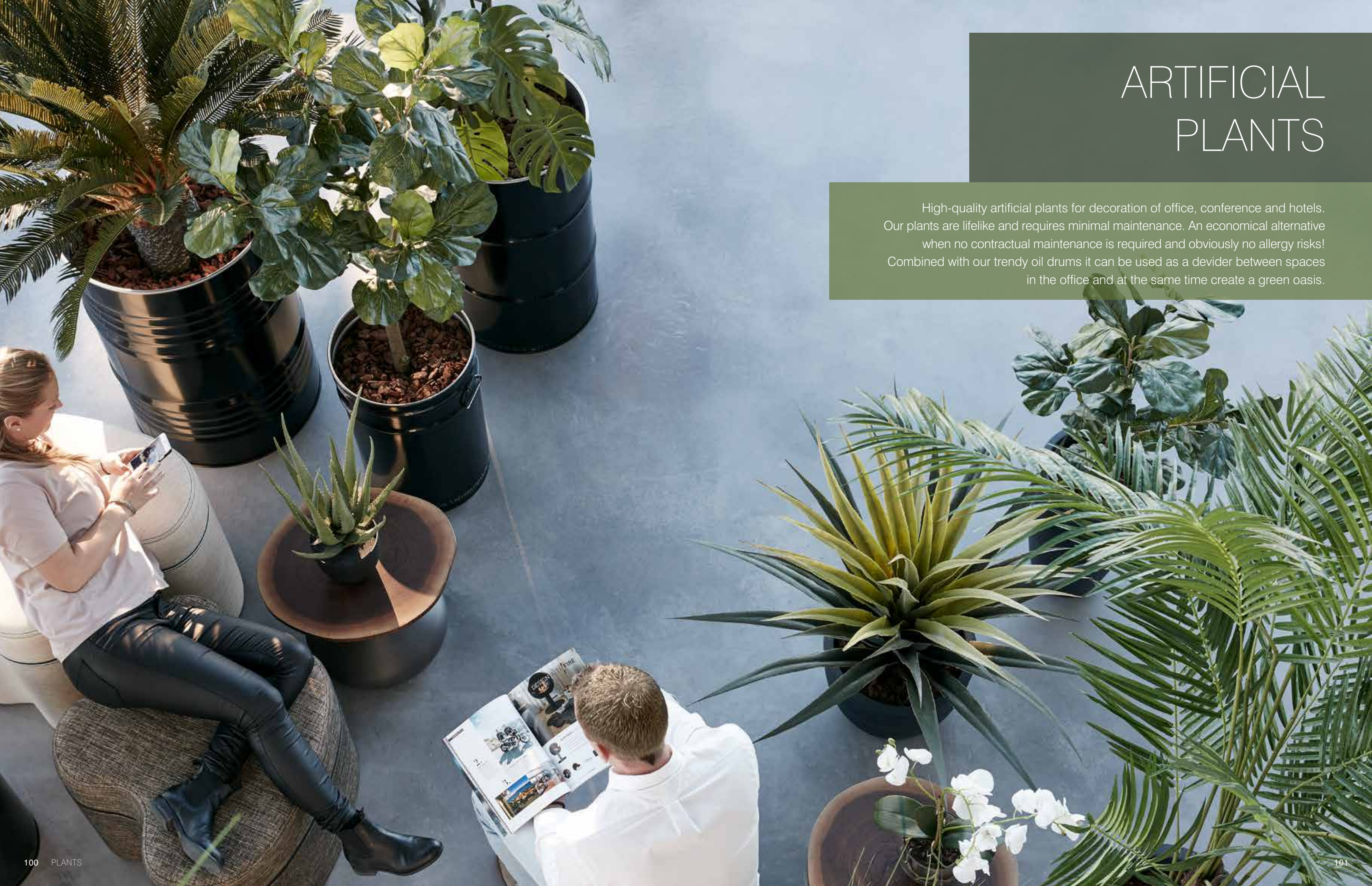



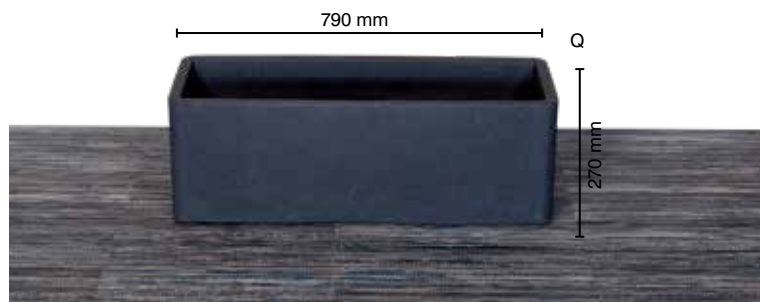

## ARTIFICIAL PLANTS

Art.No	Size/Description <i>(all dimensions in mm)</i>	Colour
--------	---	--------

### ARTIFICIAL PLANTS

High-quality artificial plants for decoration of office, conference and hotels. Plants are lifelike and requires minimal maintenance and also very good against allergies.

A	<b>Areca Palm</b> 160000 H. 2100	Green
B	<b>Monstera</b> 160001 H. 1500	Green
C	<b>Fiddle Leaf Fig Tree Small</b> 160002 H. 900	Green
D	<b>Fiddle Leaf Fig Tree Large</b> 160003 H. 1500	Green
E	<b>Agave</b> 160006 H. 1100	Green
F	<b>Olive tree</b> 160005 H. 1600	Green
G	<b>Cycas Palm</b> 160004 H. 1300	Green
H	<b>Aloe Vera incl. black pot</b> 160007 H. 550	Green
I	<b>Grass small</b> 160008 H. 950	Green
J	<b>Grass large</b> 160009 H. 1300	Green
K	<b>Orchid Phalaenopsis incl. glass pot</b> 160010 H. 650	White
L	<b>Bamboo Small</b> 160012 H. 1500	Green
M	<b>Bamboo Large</b> 160013 H. 1800	Green

Note: Oil Drum and Plant Pots not included, unless otherwise specified. Although it's in the picture.

## OIL DRUM AND PLANT POT

Art.No	Size/Description <i>(all dimensions in mm)</i>	Colour
--------	---	--------

### OIL DRUM AND PLANT POT

Plant pots with large green trees can be used as a divider between spaces in the office and at the same time create a green oasis.  
Tip: fill the pot with plastic, styrofoam etc. to place the tree higher, then cover the surface with mulch.

N	<b>Oil drum Large 216 Liter</b> 160020 H. 860 W. 600	Black
O	<b>Oil drum Medium 120 Liter</b> 160021 H. 815 W. 480	Black
P	<b>Oil drum Small 64 Liter</b> 160022 H. 590 W. 400	Black
Q	<b>Plant Pot Rectangle</b> 160028 H. 270 W. 790 D. 290	Grey
R	<b>Plant Pot Large</b> 160024 H. 700 W. 420	Grey
S	<b>Plant Pot Medium</b> 160025 H. 530 W. 305	Grey
T	<b>Plant Pot Small</b> 160026 H. 310 W. 400	Grey
U	<b>Mulch 40 Liter</b> 160030	Nature

Note: Plant Pot Medium and Small is not recommended for the Cycas and Areca Palm Tree. As our oil drums come from an industrial environment, the products have a certain patina. This is part of the design.

## OIL DRUM WITH LID

Our steel drums come with a lid. A fun tip is to personalize it. Perfect for fairs, events and in the lounge.



A. Areca Palm



B. Monstera



C. Fiddle Leaf Fig Tree Small



D. Fiddle Leaf Fig Tree Large



E. Agave



F. Olive Tree



G. Cycas Palm



I. Grass in a pot Small

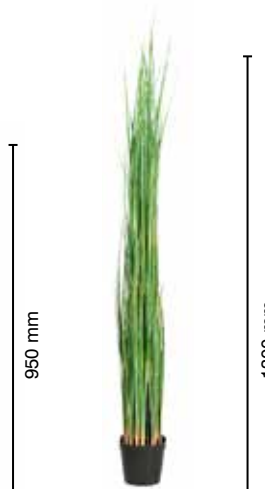

J. Grass in a pot Large



L. Bamboo in a pot Small



M. Bamboo in a pot Large



U. Mulch

Tip!  
All our plants are available in pCon planner.



# LIGHTING

At Gotessons we are investing in efficient, quality lighting with modern design and very competitive pricing. We offer desk lamps with good details for optimal lighting ergonomics to your office, one also as a floor-lamp. We also have lighting integrated in absorbers which is perfect in large rooms such as conference rooms.





## THE LIGHTNING FLOOR LAMP

With stylish design and a good ergonomically correct light that illuminates both upwards and downwards. A modern LED module design with touch buttons for brightness adjustment in three different positions. LEDs have an extremely long life span. Also available as a desk lamp, see image on page 107.

## THE LIGHTNING

Art.No	Size/Description (all dimensions in mm)	Colour
--------	--	--------

### THE LIGHTNING FLOOR LAMP

Floor lamp.

821050-1	See drawing	white
821050-2	See drawing	black

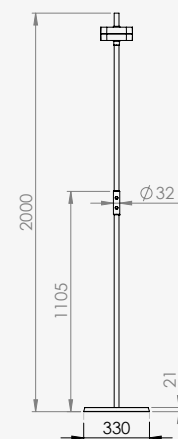

Wattage (Whole Lamp):30+30 LED  
Voltage: AC 100-240V DC 24V  
Lumens: ≥4400LM  
Color Temp:4000K  
LUX: 1200/1000 mm  
CRI:>80



### THE LIGHTNING DESK LAMP

Can be mounted on the desk or in a Table Top with hole for a lamp.  
Drilled hole Ø25 mm.

821055-1	See drawing	white
821055-2	See drawing	black

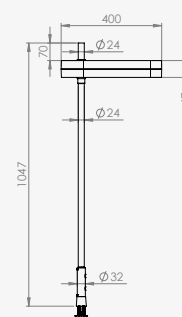

Wattage (Whole Lamp):30+30 LED  
Voltage: AC 100-240V DC 24V  
Lumens: ≥4400LM  
Color Temp:4000K  
LUX: 1200/1000 mm  
CRI:>80

### Table Top with hole for The Lightning



Table Top with a hole suitable for The Lightning. 3 m extension cable included. No other cables included. Can be ordered with other sockets. Max desk thickness 50 mm. Depth 83 mm. 1 ext, 2 USB charge.

Table cut out: 131x73 mm and drilled hole Ø25 mm.

821061-1	white
821061-2	black

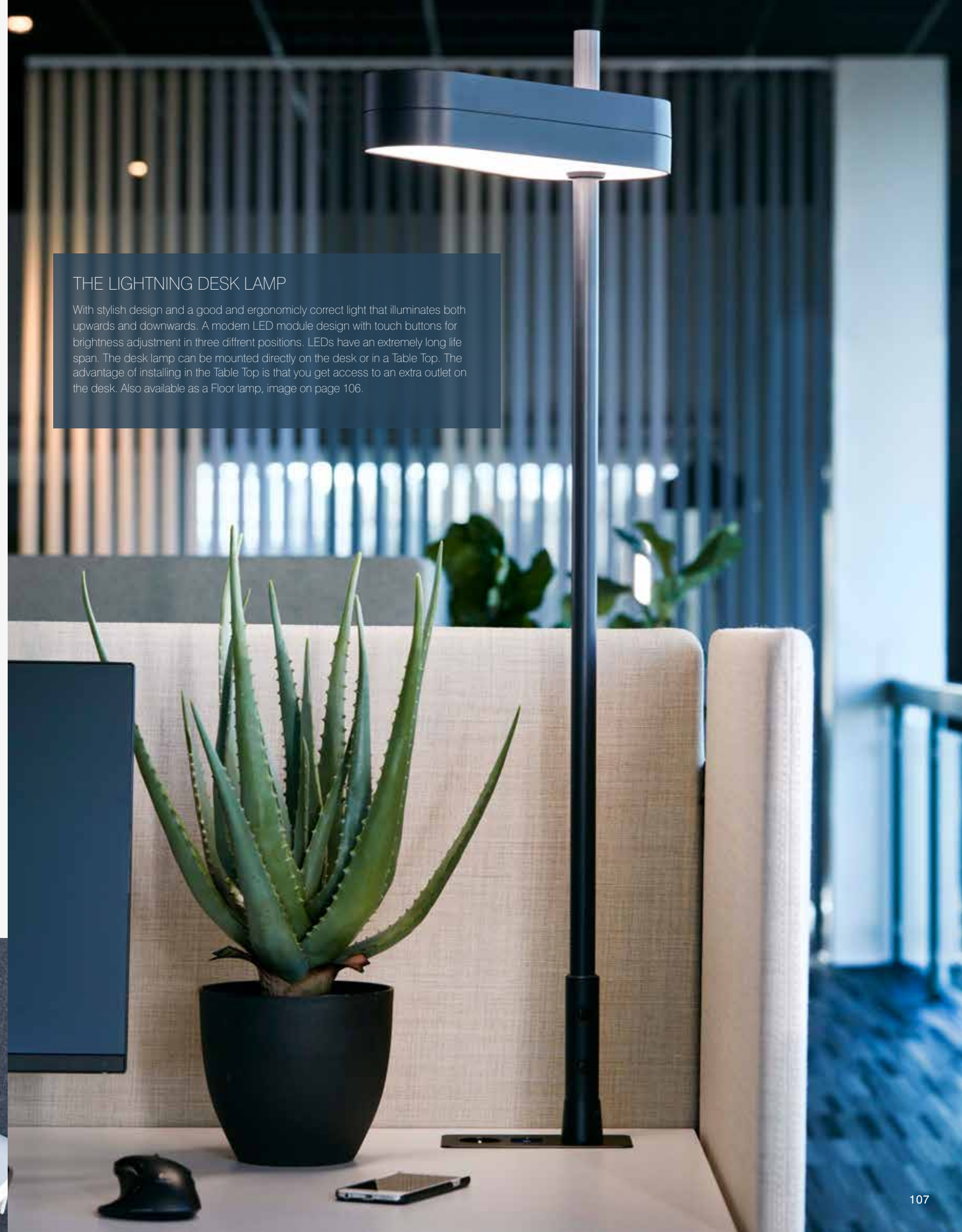

## THE LIGHTNING DESK LAMP

With stylish design and a good and ergonomically correct light that illuminates both upwards and downwards. A modern LED module design with touch buttons for brightness adjustment in three different positions. LEDs have an extremely long life span. The desk lamp can be mounted directly on the desk or in a Table Top. The advantage of installing in the Table Top is that you get access to an extra outlet on the desk. Also available as a Floor lamp, image on page 106.





## DESK LAMP LED TULIP

Art.No	Size/Description <i>(all dimensions in mm)</i>	Colour
--------	---	--------



<b>DESK LAMP LED TULIP</b>		
Desk lamp with USB charger.		
821005	See drawing	white/black



Wattage (Whole Lamp): 8W LED  
 Voltage: AC 100-240V DC 12V  
 Lumens: ≥300LM  
 Color Temp: 4000-6500K  
 LUX: max 900  
 CRI: >80  
 Reflector (non dazzling)  
 Beam angle: 120°



**Tray for Tulip for A30**  
 W. 172 H. 300  
 637117-1 white -2 black

**Tray for Tulip for Freewall**  
 W. 172 H. 190  
 671087-1 white -2 black

## DESK LAMP LED TULIP

Very affordable, efficient and foldable desk lamp with LED lighting. Touch controls for dimming and colour temperature adjustment. 0.7 A USB port for charging mobile phone etc. Now also available as an accessory for hanging on a toolbar rail or over our ScreenIT A30 products.



Tulip in folded position



Tulip in unfolded position



Tulip on A30 with built in rail.





## SILENT PENDANT LAMP

A molded lamp which thanks to its shape spreads a wonderful light and improves the acoustics of the room. The lamp screen is available in several colors and is nice to hang next to The Hut Lamp. See image on page 55 for inspiration.

## LAMP SILENT PENDANT LAMP

Art.No	Size/Description <i>(all dimensions in mm)</i>	Colour
--------	---	--------



### Lamp for *Silent Pendant Lamp*

A simple pendant with a decorative, black textile cord with a copper base. 5 m cord with E27 base. A nice LED-lamp included. Luminans: 540LM. Colour temp: 2300K. LUX: 360.

821040

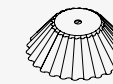

### Lamp screen for *Silent Pendant Lamp*

Silent Pendant Lamp is a collection of lampshades designed to compliment the Silent Pendant roof pendant. A molded screen in felt that thanks to its shape spreads a beautiful light and improves the acoustics of the room. The lamp comes in several colors.

Outside dark grey. Inside dark grey. 821041	Ø 594, H:200	dark grey
Outside light grey. Inside light grey. 821042	Ø 594, H:200	light grey
Outside green. Inside dark grey. 821043	Ø 594, H:200	green/dark grey
Outside blue. Inside light grey. 821044	Ø 594, H:200	blue/light grey

## THE HUT LAMP



### The Hut Lamp

A simple and decorative roof pendant for a light bulb. Works as well as solitary as hanging next to Silent Pendant Lamp. The bracket is in brass with 5 m black textile cord and black switch. A stylish LED lamp included. The industrial lamp is part of The Hut Collection and is used to advantage in our various "houses" from that series. Read more about the collection on page 54.

821020



Lamp for Silent Pendant Lamp



The Hut Lamp



Silent Pendant Lamp, consists of lamp and lamp screen together.





## MONITOR ARMS

Free up space, improve ergonomics, increase efficiency. A good monitor arm is an easy way to achieve major improvements. We have a wide selection of wall and desk arms for monitor screens in all environments.





## ZAP

A stable, diverse and very affordable mechanical spring arm with ideal ergonomic features for office use. Weight span adjusted by a mechanical spring. Black cable holder with fishbone zip included. Three mounting options are included. ZAP can also be mounted on Toolbar. See page 37.



## PRODUCT INFORMATION

Art.No	Size/Description	Colour
--------	------------------	--------

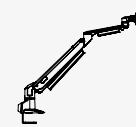

### ZAP Monitor arm

Monitor arm that is weight span adjusted by a mechanical spring. Adjustable in all positions. Rotates 360°. Tilttable 185°. VESA 75 and 100.

615525	Weight span 1,5-7 kg	silver
615525-1	Weight span 1,5-7 kg	white
615525-2	Weight span 1,5-7 kg	black

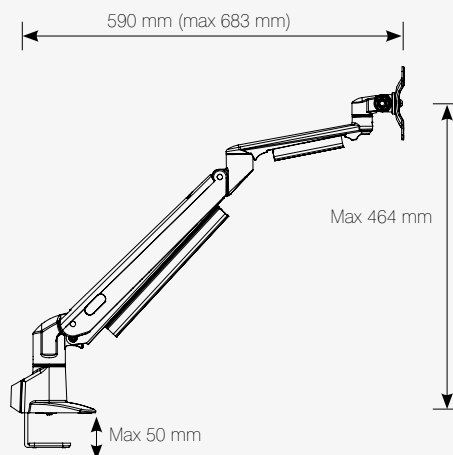

### Mounting options included

Desk clamp, through desk, grommet hole 80 mm (not Twin). For mount on toolbar, see page 37.

### Reach

Extension from 90 to 683 mm, vertical range 464 mm. Rotation 360 degrees. Tilt 180 degrees.

### VESA Monitor mount

VESA mount 75 and 100.

### Product weight

Gross weight 4,2 kg, net weight 3,5 kg.



### ZAP Monitor arm Twin

Monitor arm that is weight span adjusted by a mechanical spring. Adjustable in all positions. Rotates 360°. Tilttable 185°. VESA 75 and 100. Includes 2 arms and 1 pc of twin clamp. Please note, Twin arm is not suitable for a grommet hole 80 mm.

618525	Weight span 1,5-7 kg/arm	silver
618525-1	Weight span 1,5-7 kg/arm	white
618525-2	Weight span 1,5-7 kg/arm	black

Tip!  
ZAP single, also suited for through desk mount (standard 80 mm).

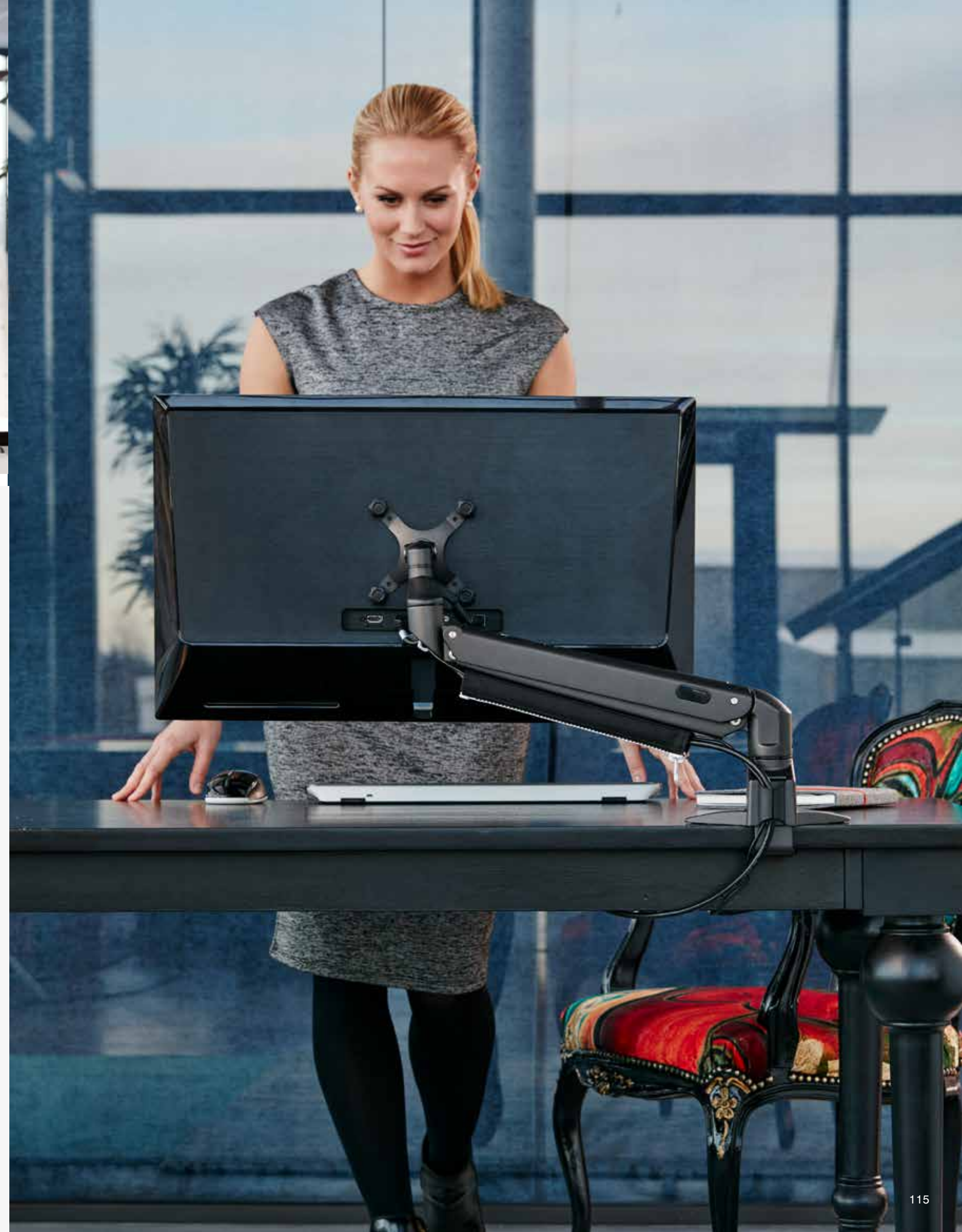





## D-ZINE

A stable, diverse and very affordable gas spring arm with ideal ergonomic features for office use and wall mount for the home, hotel room or public spaces. Can also be mounted on toolbar and wall, see page 39 and 119.



Smart clamp concept, more stable occupying minimal bracket space under the desk.



### YOU D-ZINE!

Four graphic inlays design options included.



Weight span scale.

## D-ZINE MONITOR ARM

Art.No	Size/Description (all dimensions in mm)	Colour
--------	--	--------

### D-Zine

The gas arm adjusts to the weight of the screen. Adjustable in all positions. Rotate 360°. Tilttable 185°. VESA 75 and 100. 4 graphic inlays included.

612525	Weight span 1,5-8,5 kg	silver
612525-1	Weight span 1,5-8,5 kg	white
612525-2	Weight span 1,5-8,5 kg	black
612526	Weight span 8-16 kg	silver
612526-1	Weight span 8-16 kg	white
612526-2	Weight span 8-16 kg	black

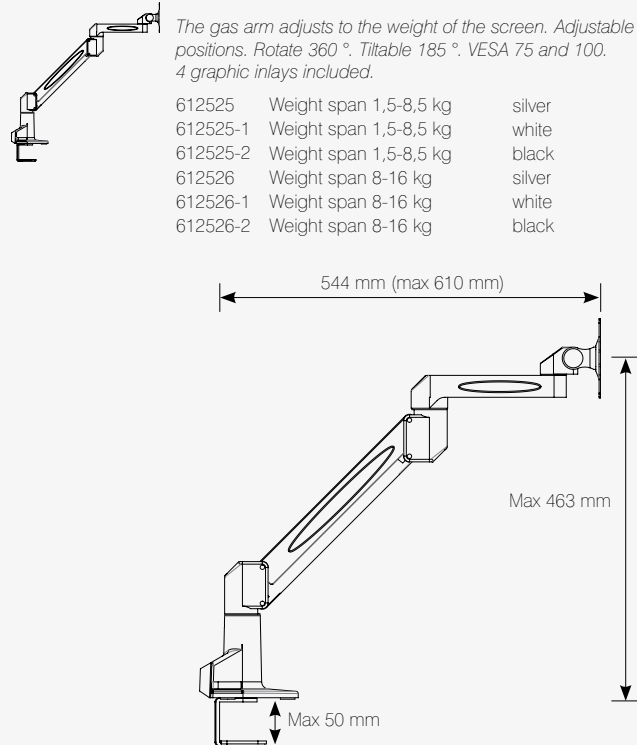

### Mounting options included

Desk clamp, through desk, grommet hole 80 mm. For mount on toolbar, see page 37.

### You D-Zine

Four graphic inlay design options included.

### Reach

Extension from 90 to 610 mm, vertical range 463 mm. Rotation 360 degrees. Tilt 180 degrees.

### VESA Monitormount

VESA 75 and 100 is included.

### Product weight

Gross weight 4,2 kg, net weight 3,5 kg.

### Accessories D-Zine

#### Gotessons Double bracket

Length 740 mm. Max width 670 mm/monitor. Weight 2 kg.

610504		silver
610504-1		white
610504-2		black



#### Metal plate for angled edge desks

When the clamps need stable grip with angled edge. 66500 W. 80 L. 100 silver

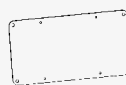

#### VESA-adapter plate 200x100

Adapter VESA attachment plate for 200x100 mm. Fits all arms. For larger monitors.

610700		silver
--------	--	--------



#### VESA-adapter plate 200x200

Adapter VESA attachment plate for 200x200 mm. Fits all arms. For larger monitors.

610705		black
--------	--	-------

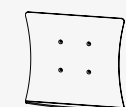

#### Laptop shelf for monitor arm

To be mounted to a separate arm. Suits VESA 100. Incl. velcro and elastics. See page 36.

671097	350x320 mm	silver
671097-1	350x320 mm	white
671097-2	350x320 mm	black



## V3 MONITOR ARM

A competitive priced monitor arm with both clamp and desk mount option in one.

## V3 MONITOR ARM

Art.No	Size/Description (all dimensions in mm)	Colour
--------	--	--------

### V3 Monitor arm

Powder coated steel. Max height 400 mm. Max weight capacity 8 kg. Max armlength 420 mm. Rotates 360°. It comes with a desk clamp (60 mm) also suited for through desk mount (standard 80 mm). Incl. VESA attachment standard 75 and 100.

610510-50		silver
610510-60		white
610510-70		black

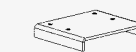
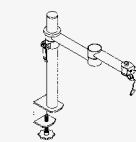

#### Metal plate for angled edge desks

When the clamps need stable grip with angled edge. 66500 W. 80 L. 110 silver



#### VESA-adapter plate 200x100

Adapter VESA attachment plate for 200x100 mm. Fits all arms. For larger monitors.

610700		silver
--------	--	--------

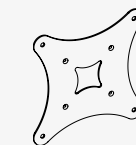

#### VESA-adapter plate 200x200

Adapter VESA attachment plate for 200x200 mm. Fits all arms. For larger monitors.

610705		black
--------	--	-------







### ZAP TWIN

Monitor arms with mechanical spring. Contains 2 arms and 1 pc twin mount for the two arms.



### D-ZINE DOUBLE COMPLETE

Double bracket for monitor, VESA 75 and 100.



### V3 WITH GOTESSONS DOUBLE BRACKET

Double bracket for monitor, VESA 75 and 100.

### V3 WITH SINGLE ARM AND LAPTOP SHELF



## MONITOR ARMS DOUBLE

Art.No Size/Description Colour  
(all dimensions in mm)

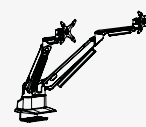

#### ZAP Twin

Monitor arms with mechanical spring which is adjusted for the weight of the screen. Adjustable in all positions. Rotatable 360°. Tilttable 185°. VESA 75 and 100. Includes 2 arms and 1 pc twin mount for the two arms.

618525	Weight span 1,5-7 kg/arm	silver
618525-1	Weight span 1,5-7 kg/arm	white
618525-2	Weight span 1,5-7 kg/arm	black

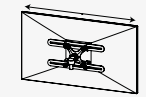

#### VESA-adapter for ZAP Twin monitor arm

VESA adapter to adjust the screens sideways. The screens will always stay poerm each other without changing the screen distance. Max weight / monitor 6 kg.

610610-2	W. 280 mm	black
----------	-----------	-------

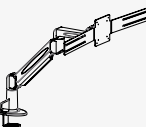

#### D-Zine Double complete

D-Zine arm with Gotessons Double bracket. Gotessons Double bracket weight 2 kg. Max weight each monitor, see below.

613525	Weight span 1,5-8,5 kg (3 kg)	silver
613525-1	Weight span 1,5-8,5 kg (3 kg)	white
613525-2	Weight span 1,5-8,5 kg (3 kg)	black
613526	Weight span 8-16 kg (5 kg)	silver
613526-1	Weight span 8-16 kg (5 kg)	white
613526-2	Weight span 8-16 kg (5 kg)	black



#### Gotessons Double bracket

Length 740 mm. Max width 670 mm/monitor. Weight 2 kg.

610504	silver
610504-1	white
610504-2	black

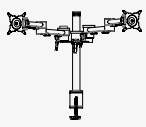

#### V3 Twin complete

1 pc 400 mm post, 1 pc Twin mount, 2 arms. Max 4 kilo each arm.

610511-50	silver
610511-60	white
610511-70	black

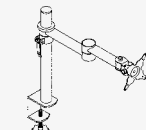

#### V3 Monitorarm

Powder coated steel. Max height 400 mm. Max weight capacity 8 kg. Max armlength 420 mm. Rotates 360°. It comes with a desk clamp (60 mm) also suited for through desk mount (standard 80 mm). Incl. VESA attachment standard 75 and 100.

610510-50 L. 420	silver
610510-60 L. 420	white
610510-70 L. 420	black



#### V3 Post 700 mm

Including desk clamp.

610562	silver
610562-1	white
610562-2	black



#### V3 Twin mount

For mounting two arms on one post. Order with one V3 Monitor arm and one V3 Single arm.

610516-50	silver
610516-60	white
610516-70	black

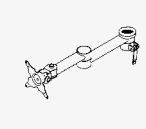

#### V3 Single arm without post

Max weight capacity 8 kg.

610517	L. 420	silver
610517-1	L. 420	white
610517-2	L. 420	black

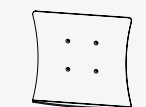

#### Laptop shelf for monitor arm

To be mounted to a separate arm. Suits VESA 100. Incl. velcro and elastics.

671097	320x350 mm	silver
671097-1	320x350 mm	white
671097-2	320x350 mm	black



#### Telephone/client holder for monitor arm

To be mounted to a separate arm. Suits VESA 100.

671095	230x240 mm	silver
671095-1	230x240 mm	white
671095-2	230x240 mm	black

Double bracket = one bracket for two monitors.  
Twin mount = one bracket for two separate monitors.



### D-ZINE WALL 2



### D-ZINE WALL 4



### SLIM TV-MOUNT

Slim TV-mount: flexible bracket, turnable, rotatable with integrated cabling. 46 mm from the wall.

### KEYBOARD HOLDER



## MONITOR ARMS WALL

Art.No Size/Description Colour  
(all dimensions in mm)

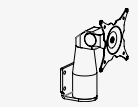

#### D-Zine Wall 1

Max load 12 kg. L. 105 H.135  
611527 silver -1 white -2 black

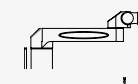

#### D-Zine Wall 2

Max load 12 kg. L. 280 H. 135  
611528 silver -1 white -2 black

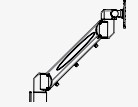

#### D-Zine Wall 3

Gas arm. Incl. wall mount. Load span 1,5-8,5 kg. L. 470 H. 350  
612325 silver -1 white -2 black

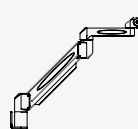

#### D-Zine Wall 4

Gas arm. Incl. wall mount. Load span 1,5-8,5 kg. L. 650 H. 415  
612425 silver -1 white -2 black

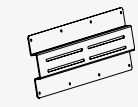

#### D-Zine Wallbracket

A larger mount space. 250x150 mm.

610609 silver -1 white -2 black

A larger mount space. 640x230 mm.

610608 silver -1 white -2 black

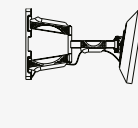

#### Slim TV-mount

Plasma/LCD/LED wall mount. Swivel 180° and tilttable -2°/+10°. For most 32"-60" screens. Max weight 36 kg. Arm length 46-488 mm.  
610566-2 black



#### Keyboard holder

Shelf: 650x220 mm.VESA 75 och 100.

610604 silver -1 white -2 black

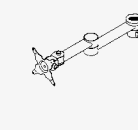

#### V3 Single arm without post

L 420 mm.

610517 silver -1 white -2 black



#### V3 Twin mount

For mounting two arms on one post. Order with one V3 Monitor arm and one V3 Single arm.

610516-50 silver -60 white -70 black

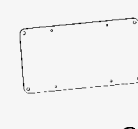

#### VESA-adapter plate 200x100 mm

Adapter VESA attachment plate. Fits all arms. For larger monitors.

610700 silver

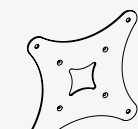

#### VESA-adapter plate 200x200 mm

Adapter VESA attachment plate. Fits all arms. For larger monitors.

610705 black

Tip!  
See all arms, pictures and videos at  
[www.gotessons.com](http://www.gotessons.com)



A man in a light-colored suit jacket and a grey cardigan is sitting at a desk. He is holding a white cable in his right hand. On the desk in front of him is a silver laptop on a white holder. The background is a blurred office setting.

# CPU / LAPTOP HOLDERS CABLE HOLDERS CABLE COLLECTORS RECYCLING

CPU/ laptop holders not only save space at the workstation, they are also equally practical and ergonomical. A full range of products in all shapes, sizes and budgets including anti-theft solutions.

Cable clutter, not only aesthetically a nightmare, it increases the risk of fire. Good cable management results in better hygiene and makes cleaning office spaces more efficient.





### SETUPIT

A rotating recycling station with removable containers for paper and other materials.

### SETUPIT WITH PULL-OUT PEN DRAWER

Suits well without distances on most desktops.



SetUpit silver



SetUpit black



SetUpit with lid



SetUpit is also available in more colours. Please, contact us for more information regarding price and delivery time.



SetUpit with Sopi



SetUpit 3

## SETUPIT

Art.No	Size/Description <i>(all dimensions in mm)</i>	Colour
--------	---	--------

### SETUPIT

1 rotatable metal post, 1 plastic container for paper and for other materials. Includes mounting screws.

610070	D. 290 W. 255 H. 386	black
610071	D. 290 W. 255 H. 386	silver grey
610072	D. 290 W. 255 H. 386	white
610570	With runner	black
610571	With runner	silver grey
610572	With runner	white

### SetUpit with lid

1 rotatable metal post, 1 plastic container for paper and 1 for other materials with lid. Includes mounting screws.

610074	D. 290 W. 255 H. 386	black
610073	D. 290 W. 255 H. 386	silver grey
610076	D. 290 W. 255 H. 386	white
610574	With runner	black
610573	With runner	silver grey
610576	With runner	white

### SetUpit with Sopi plastic bags

1 rotatable metal post, 1 plastic container, 1 Sopi plastic bag holder. Includes mounting screws.

610080	D. 170 W. 255 H. 386	black
610081	D. 170 W. 255 H. 386	silver grey
610082	D. 170 W. 255 H. 386	white
610580	With runner	black
610581	With runner	silver grey
610582	With runner	white

### SetUpit 3

1 rotatable metal post, 1 plastic container for paper, 1 for other materials and 1 Sopi bag holder. Includes mounting screws.

610078	D. 290 W. 255 H. 386	black
610077	D. 290 W. 255 H. 386	silver grey
610079	D. 290 W. 255 H. 386	white
610578	With runner	black
610577	With runner	silver grey
610579	With runner	white

SetUpit can also be made in more colours. Please contact us for more information about quantities, delivery time and price.

### SetUpit with pull-out pen drawer complete

Complete with pen drawer, 1 rotatable metal post, 1 plastic container for paper and 1 for other materials. Includes mounting screws.

650045-1	D. 265 W. 255 H. 550	white
650045-3	D. 265 W. 255 H. 550	silver

### Height distances

871003	H. 65	silver
871003-1	H. 65	white

### ACCESSORIES:

#### Plastic bags for the small container

610252	Rolls/320 units	transparent
--------	-----------------	-------------

#### Bags for the small container

100% biodegradable.

610272	Rolls/25 units
--------	----------------

#### Sopi plastic bags

610262	25 units	silver
--------	----------	--------



## SETUPIT

A rotating recycling station which takes little space underneath your desk. Built on a rotating system with removable containers for paper and other materials. Comes in silver, black or white. Patented construction.







## BRINGIT

Bringit is a storage bag in grey felt for your laptop, keyboard, mouse and personal belongings. Available with different colors on zipper. The bag is perfect for the activity-based office. It has a pocket card on the outside and has a divider on the center of the inside. There are two pockets inside for pens and small items. Hang it under your desk at the workplace on a hook for Bringit.



## DOCKIT DESIGN

Push/pull and rotate for laptop/docking station and horizontal computers.



## CPU HOLDER WITH LOCKABLE TRAY

Flexible holder that takes little vertical space under the desk. Fits both standard CPU and laptop with or without the dockingstation. With bag hook on the outside.

## LAPTOP HOLDERS

Art.No    Size/Description    Colour  
(all dimensions in mm)

### BringIT Laptop Bag

Storage bag in grey felt material for Laptops etc.  
W: 350 H: 310 D: 110  
Available in other zip colours, please contact us for quotation.



640085-100	Grey with white zip	
640085-105	Grey with red zip	
640085-106	Grey with silver zip	



### Hook for BringIT Laptop Bag

Hook to be mounted under the desk. Screws included.  
671088-1 white -2 black -3 silver

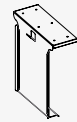

### CPU holder

CPU/laptop holder for more space under the desk. Can be used with or without docking station. Max height 430 mm.

650019-1	W. 140 H. 435 D. 310	white
650019-3	W. 140 H. 435 D. 310	silver



### Height distances

871003	H. 65	silver
871003-1	H. 65	white

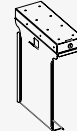

### CPU holder with lockable tray complete

Height distances included.

650039-1	W. 174 H. 520 D. 424	white
650039-3	W. 174 H. 520 D. 424	silver

To order only lockable tray, see page 92.



### DockIT Design without runner

Bended steel tube with shelf made of anodized aluminium.  
125 mm between shelf and bracket.

551000	Inside 370x370 mm	silver
551010	With rubber mat	silver

### DockIT Design with runner and distances

551001	440 mm runner	silver
551011	440 mm runner & rubber mat	silver
551002	600 mm runner	silver
551003	600 mm runner & rubber mat	silver

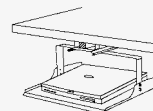

### DockIT without runner

531011	W. 350 H. 140 D. 400	silver
541011	W. 440 H. 140 D. 400	silver

### DockIT with runner and distances

531010	With 440 mm runner	silver
531012	With 600 mm runner	silver
541010	With 440 mm runner	silver
541012	With 600 mm runner	silver



## TWISTIT

Twistable and rotatable holder for laptops with or without dockingstation. Takes minimum space underneath the desk, does not need runner/ slide and can be used horizontally and vertically. The vertical/horizontal tightness can be adjusted by hand.



## LAPTOP HOLDER TWISTIT

Art.No    Size/Description    Colour  
(all dimensions in mm)

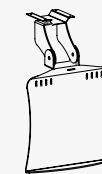

### TwistIT

Twistable and rotatable holder for laptops and small cpu's, with or without docking station. Recommended max weight 5 kg, 10 kg as permanent vertical position.

### TwistIT without runner

551031	W. 350 H. 350	silver
551031-1	W. 350 H. 350	white
551031-8	W. 350 H. 350	black

### TwistIT with runner and distances

551030	440 mm runner	silver
551030-1	440 mm runner	white
551030-8	440 mm runner	black

### TwistIT Big without runner

551033	W. 380 H. 400	silver
551033-1	W. 380 H. 400	white
551033-8	W. 380 H. 400	black

### TwistIT Big with runner and distances

551032	440 mm runner	silver
551032-1	440 mm runner	white
551032-8	440 mm runner	black





### LAPTOP BOX

Lockable box for laptop/docking station with extendable shelf and notch for cables in the back.



### LAPTOP LOCKABLE DRAWER

Available in silver and white.

## LAPTOP HOLDERS

Art.No	Size/Description (all dimensions in mm)	Colour
--------	--	--------

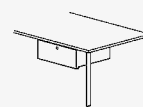

#### Laptop Box

Anti-theft for laptop with extendable plate. Inner dimensions.

866000-3	W. 380 H. 110 D. 420	silver
866000-1	W. 380 H. 110 D. 420	white
866010-3	W. 380 H. 60 D. 410	silver
866010-1	W. 380 H. 60 D. 410	white

#### Height distances for Laptop box

4 distances, mounting kit with 2 profiles of flat iron to increase stability, 60x60 mm.

850010-3 silver -1 white



#### Laptop lockable draw

Thin metal lockable drawer with rubber inlay to be mounted under the desk for laptop no bigger than 400x300 mm. Not suitable with Gotessons height distances and SetUpit. Inner dimensions.

651070	W. 400 H. 65 D. 300	silver
651070-1	W. 400 H. 65 D. 300	white

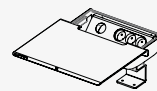

#### Power Shelf

The shelf can slide forward. When closed keeping all cables out of sight. The Power shelf contains 3 electrical sockets and a hole for retractable cables. Standard CE schuko sockets. For other sockets ask us for a quote.

673003	W. 370 D. 300 H. 115	silver
673003-1	W. 370 D. 300 H. 115	white
673015	Desk clamp	black

## POWERSHELF

A pull-out slide shelf with three sockets and a hole for retractable cables. Order clamp separately.



## FLOOR/WALL CABLE COLLECTOR ALUMINIUM

Floor canal system made of aluminium, screwed or taped to the floor. The lower part is fastened to the floor/wall and the cover is clicked into place.



## HALFMOON ROTATABLE PEN DRAWER

Rotatable pen drawer with small sections and holder for tape.



## PULL-OUT PEN DRAWER WITH LOCK

With the possibilities to mount the SetUpit under this drawer. See page 122-123.

## FLOOR COLLECTOR/PULL OUT DRAWER

Art.No	Size/Description (all dimensions in mm)	Colour
--------	--	--------

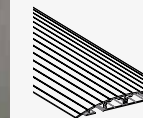

#### Gotessons Floor Cable Collector Aluminium

Floor canal system made of aluminium, screwed or taped to the floor. W. 155 mm. H. 17 mm. Can be ordered in any length. Contact us for price.

732080	800	silver
732120	1200	silver
732160	1600	silver
732200	2000	silver
732300	3000	silver

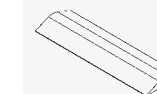

#### Floor Cable Collector (environment friendly TPE plastic)

Price/metre, easy to cut. W. 76, H. 15. Order tape separately.

730000 grey

#### Tape

Self adhesive tape for floor cable collectors. Consumption 2 pcs/floor cable collector. 731000

#### PEN DRAWER

##### Halfmoon rotatable pen drawer

Rotatable pen drawer with sections and holder for tape. External dimension.

651060	W. 340 H. 34 D. 197	silver
651060-2	W. 340 H. 34 D. 197	black

#### PULL-OUT PEN DRAWER WITH LOCK

##### Narrow pull-out pen drawer Mini

650079-1	W. 144 H. 51 D. 265	white
650079-3	W. 144 H. 51 D. 265	silver

##### Narrow pull-out pen drawer

650049-1	W. 144 H. 51 D. 400	white
650049-3	W. 144 H. 51 D. 400	silver

#### Height distances

871003	H. 65	silver
871003-1	H. 65	white

Thin metal pencil drawer with mat and plastic divider inlay to be mounted under the desk. External dimensions.



#### Pen drawer with lock Big

651069	W. 395 H. 55 D. 250	silver
651069-1	W. 395 H. 55 D. 250	white
651069-2	W. 395 H. 55 D. 250	black



#### Pen drawer with lock Small

651059	W. 320 H. 55 D. 190	silver
651059-1	W. 320 H. 55 D. 190	white
651059-2	W. 320 H. 55 D. 190	black





## SWINGIT

Rotational by 360° and with the ability to slide underneath your desk to the preferred position. Suits all computers on the market. Mounts on a runner.



## TWISTIT

For product information see page 125.



## CPU HOLDER 1

Simple model with easy and quick installation. Suits both tower and desktop models.



## CPU HOLDER WITH LOCKABLE TRAY

Suits both tower and desktop models.



## STAND

Only suits tower models. Turnable. Adjustable in heights.

## CPU HOLDERS

Art.No	Size/Description (all dimensions in mm)	Colour
--------	--	--------

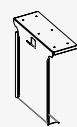

### CPU holder

CPU/laptop holder for more space under the desk. Can be used with or without docking station. Max height 430 mm.

650019-1	W. 140 H. 435 D. 310	white
650019-3	W. 140 H. 435 D. 310	silver



### Height distances

871003	H. 65	silver
871003-1	H. 65	white

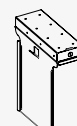

### CPU holder with lockable tray complete

Height distances included.

650039-1	W. 174 H. 520 D. 424	white
650039-3	W. 174 H. 520 D. 424	silver

To order only lockable tray, see page 92.

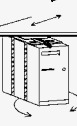

### SwingIT

Suits both tower and desktop models.

871005	Without runner	silver
871010	Complete with runner/dist.	silver



### CPU holder 1

2 flat metal profiles, 2 straps (L.1700 mm), mounting kit.

872300	Tower model/desktop model	silver
872310	Tower model for thick framed desks.	silver

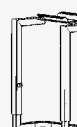

### Stand CPU holder

H. 330 - 540 mm, D. 135 mm.

877000	Without runner	silver
877010	With runner and distances	silver

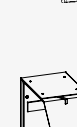

### Anyway CPU-holder

Fits tower model, width adjustable from 90-250 mm, height adjustable from 300-600 mm.

650000	Tower model without runner	silver
650000-1	Tower model without runner	white
650000-2	Tower model without runner	black
650007	Tower model with runner	silver
650007-1	Tower model with runner	white
650007-2	Tower model with runner	black
650008	For wall mount	silver



### Height distances

871003	H. 65	silver
871003-1	H. 65	white
871003-8	H. 65	black



### Client Box

Anti-theft for thin clients or small CPU-units.

860100-1	W. 105 H. 255 D. 305	white
860100-3	W. 105 H. 255 D. 305	silver



860150-1	W. 160 H. 310 D. 355	white
860150-3	W. 160 H. 310 D. 355	silver



## G-BOX

Burglar-proof with high test values and made from powder coated steel, designed for both tower and desktop models. Comes with a padlock (class 2) and a lockable brace. Adjustable to three different heights. We also tailor make special boxes on client order.



## G-BOX



- Skafor certified (blue class)
- Certified by the Swedish Theft Prevention Association\*

\*The certification by the Swedish Theft Prevention Association is only valid when the G-box is mounted with 2 through screw bolts.

## BOXUP

BoxUp is width adjustable 130-230mm and will fit most CPU:s. The lockable brace is adjustable. BoxUp is a safety box, available in tower and desktop models.



## BOXUP

Desktop model.



## BOXUP

Tower model.

## CPU HOLDERS

Art.No	Size/Description (all dimensions in mm)	Colour
--------	--	--------

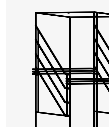

### G-box – tower model

(inner measurements)

845100	W. 130 H. 390 D.380	black/silver
845130	W. 130 H. 480 D.500	black/silver
845180	W. 180 H. 480 D.500	black/silver
845220	W. 220 H. 480 D.500	black/silver
845260	W. 260 H. 480 D.500	black/silver

### G-box – cube model

845225	W. 220 H.250 D. 320	black/silver
--------	---------------------	--------------



### G-box - horizontal

833100	W. 390 H. 130 D.380	black/silver
833131	W. 450 H. 130 D.500	black/silver
833181	W. 450 H. 180 D.500	black/silver

### G-box wall mount

Complete G-box with padlock and 2 distances (60x60x490 mm) for wallmount.

846100	W. 130 H. 390 D.380	black/silver
846130	W. 130 H. 480 D.500	black/silver
846180	W. 180 H. 480 D.500	black/silver
846220	W. 220 H. 480 D.500	black/silver
846260	W. 260 H. 480 D.500	black/silver

### G-box special

850000	Special dimensions	black/silver
--------	--------------------	--------------

Hardened brace with a powerful pad lock, vibration/noise absorbing polyethylene mat, high quality self-adhesive tape, STOP decal, 2 through screw bolts.

### Height distances G-box

850007	H. 60	black/silver
--------	-------	--------------

Note! Please specify the width of the box.

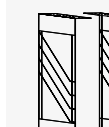

### BoxUp

BoxUp without lock, vibration/noise absorbing polyethylene mat, self-adhesive tape, installation kit.

#### Tower model

881324-2	W. 130/230 H. 485 D.465	black
881324-3	W. 130/230 H. 485 D.465	silver

#### Desktop model

881321-2	W. 485 H. 120/215 D.465	black
881321-3	W. 485 H. 120/215 D.465	silver

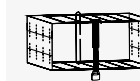

### BoxUp with lock

BoxUp, pad lock with braces, vibration/noise polyethylene mat, self-adhesive tape, installation kit.

#### Tower model

881323-2	W. 130/230 H. 485 D.465	black
881323-3	W. 130/230 H. 485 D.465	silver

#### Desktop model

881222-2	W. 485 H. 120/215 D.465	black
881222-3	W. 485 H. 120/215 D.465	silver

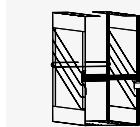

### Lock and brace package

Completion for BoxUp without lock.

881000-2	black -3 silver
----------	-----------------



### Height distances for BoxUp

4 cube formed distances, 60x60 mm.

850008-2	black -3 silver
----------	-----------------



## HALFPIPE CABLE HOLDER

Available in five different lengths. The adjustable mounting attachments and low weight makes assembly quick and easy.



Halfpipe in silver.



Halfpipe in white.



## HALFPIPE CABLE TRAY ADJUSTABLE

Halfpipe with keyhole mount for easier assembly.

## HALFPIPE

Art.No	Size/Description (all dimensions in mm)	Colour
--------	--	--------

### Cable holder Halfpipe

In cupular aluminium with adjustable turning function that allows easy cable access. Spacious, hiding large amounts of cables.

740049	L. 490 W.170 D.80	silver
740049-1	L. 490 W.170 D.80	white
740049-8	L. 490 W.170 D.80	black
740079	L. 790 W.170 D.80	silver
740079-1	L. 790 W.170 D.80	white
740079-8	L. 790 W.170 D.80	black
740115	L. 1150 W.170 D.80	silver
740115-1	L. 1150 W.170 D.80	white
740115-8	L. 1150 W.170 D.80	black
740150	L. 1500 W.170 D.80	silver
740150-1	L. 1500 W.170 D.80	white
740150-8	L. 1500 W.170 D.80	black
740170	L. 1700 W.170 D.80	silver
740170-1	L. 1700 W.170 D.80	white
740170-8	L. 1700 W.170 D.80	black

### Cable holder Halfpipe adjustable with keyhole for desks

To be mounted with screws under the desk, 2 pcs in one pack.

771100	L.1000-1800 W.170 D.80	silver
771100-1	L.1000-1800 W.170 D.80	white

### Desk mount set for Halfpipe with keyhole

To be mounted with screws under the desk, 2 pcs in one pack.

642065-1 white -3 silver

### Cable holder Halfpipe adjustable with keyhole for desk screen

770100	L.1000-1800 W.170 D.80	silver
770100-1	L.1000-1800 W.170 D.80	white

### Cable holder Halfpipe adjustable

740100	L.1000-1800 W.170 D.80	silver
740100-1	L.1000-1800 W.170 D.80	white
740100-8	L.1000-1800 W.170 D.80	black

### Cable holder Halfpipe adjustable for desk screens

760100	L.1000-1800 W.170 D.80	silver
760100-1	L.1000-1800 W.170 D.80	white
760100-8	L.1000-1800 W.170 D.80	black

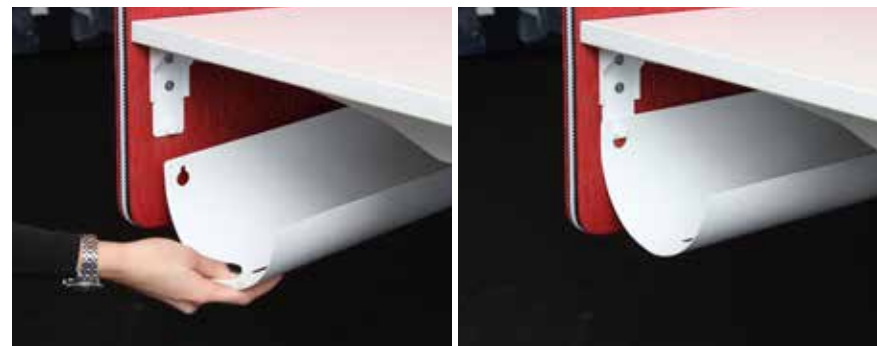

## HALFPIPE CABLE TRAY ADJUSTABLE WITH KEYHOLE

Quick fit Halfpipe. No screws needed anymore. Quick release is available for all screens as mount as well as in the ScreenIT slide rail package.

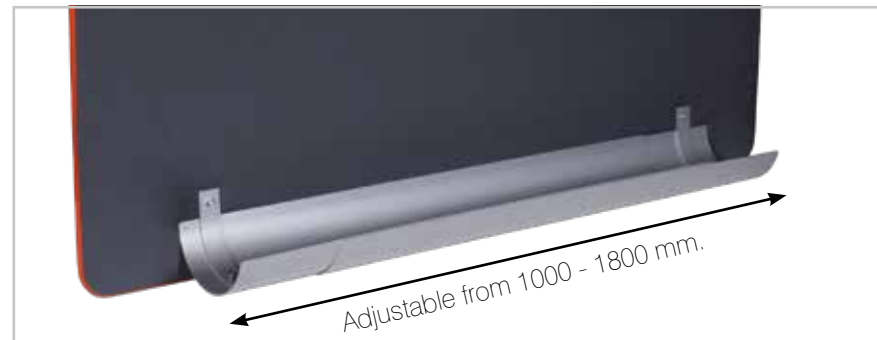

## HALFPIPE FOR DESK SCREENS

Comes prepared for quick installation of cable holder Halfpipe. For screens up to 1800 mm.



## COMPLETE SET

6-way junction box 3 m cable, 5 m net, 5 m tel. Available in more combinations. Contact Gotessons for more information.



## HALFPIPE COMPLETE

Produced for a very quick and easy assembly. Saves both time and money and most importantly, a perfect cable solution at your desk.

## HALFPIPE/COMPLETE SET

Art.No	Size/Description (all dimensions in mm)	Colour
--------	--	--------

### Complete set 3 m

Fits all cable holders. All cables are assembled in the Cable Collector Ø 22.

700900	3 m cable, 5 m net, 5 m tele	silver
700900-1		white
700900-2		black
700930	With 1x3, 1x6 sockets	silver
700905	As 700900 with 5 m cable	silver
700910	As 700900 with 10 m cable	silver

### Complete set 1,5 m

Fits all cable holders. All cables are assembled in the Cable Collector Ø 22.

700903-3	1,5 m cable, 2 m net, 2 m tele	silver
700903-1		white
700903-2		black

### Cable holder Halfpipe complete

1 cable holder Halfpipe with 2 mounting ladders, 2 plastic ends, 6-way junction box (3 m), 1 network cable Cat.6 (5 m), 1 RJ12 phone cable (5 m), 1 G-clip. All cables are assembled in the Cable Collector Ø 22 (see picture).

745049	L. 490 W.170 D.80	silver
745049-1	L. 490 W.170 D.80	white
745049-8	L. 490 W.170 D.80	black
745079	L. 790 W.170 D.80	silver
745079-1	L. 790 W.170 D.80	white
745079-8	L. 790 W.170 D.80	black
745115	L. 1150 W.170 D.80	silver
745115-1	L. 1150 W.170 D.80	white
745115-8	L. 1150 W.170 D.80	black
745150	L. 1500 W.170 D.80	silver
745150-1	L. 1500 W.170 D.80	white
745150-8	L. 1500 W.170 D.80	black
745170	L. 1700 W.170 D.80	silver
745170-1	L. 1700 W.170 D.80	white
745170-8	L. 1700 W.170 D.80	black

### Complete set with two network

6-way junction box (3 m), 2 network cable Cat.6 (5 m).

All cables are assembled in the Cable Collector Ø 22.

700902 silver, -1 white, -2 black

### Complete set for two desks

2 pcs of 6-way junction box (3 m), 2 pcs of 3-way junction box (5 m), network cable Cat.6 (7 m), network cable Cat.6 (10 m). All cables are assembled in the Cable Collector Ø 22.

700912 silver, -1 white, 2 black

### COMPLETION:

#### Halfpipe plastic end

Injection-moulded plastic. Closes of the side. Not for 770100 and 771100.

740020		silver
740020-1		white
740020-2		black

#### Assembly hook for Halfpipe

Makes it easier to assemble Halfpipe single handedly. One is enough for mounting several Halfpipes.

740010

#### G-clips

For mounting cables under the desk.

700240-1	5 clips/package Ø 20 mm	white
700240-2	5 clips/package Ø 20 mm	black
700240-3	5 clips/package Ø 20 mm	silver
700242-1	5 clips/package Ø 40 mm	white
700242-2	5 clips/package Ø 40 mm	black
700242-3	5 clips/package Ø 40 mm	silver

#### Junction box earthed

700330	3-ways earthed, 1,5 m cable	white
700333	3-ways earthed, 3 m cable	white
700410	3-ways earthed, 5 m cable	white
694500	6-ways earthed, 3 m cable	white
694550	6-ways earthed, 5 m cable	white

#### Junction box earthed with USB charging

721815	3-ways, 2USB, 1,5 m cable	black
--------	---------------------------	-------

#### Extension earthed

700600	L. 6 m	white
701000	L. 10 m	white





## BI-BOX

Cable box with bi lateral lid opening. See more information at page 138.



## QUICK CABLE HOLDER

Designed for mounting straight underneath the desk, suitable for installation under desks with visitor seats etc. Available in two lengths. Easy installation.



## G-49 AND G-79 CABLE HOLDER

Allowing cables to be routed the shortest way to your equipment. Free passage for full coverage installation beneath the steel/wood structure of your desk.



## CABLECARE CABLE HOLDER

Protected cable collection holder with a flexible system allowing holders to be connected in series to any length, for high or low mounting.



## CABLE HOLDER FOR CONFERENCE TABLES

Cable holder suitable for the Power Box. Foldable ends for optimum suitability.

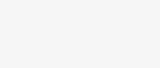
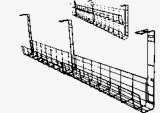
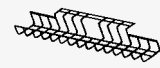
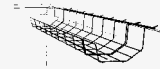
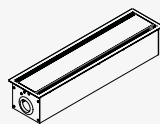
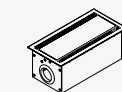

## CABLE HOLDERS

Art.No	Size/Description <i>(all dimensions in mm)</i>	Colour
--------	---	--------

### Bi-Box Small

Exterior dimensions L. 300 W. 150 D. 118  
721000 silver -1 white -2 black

### Power Inlay for Bi-Box Small

721002 3 ext, 2 net  
721003 2 ext, net, VGA, audio, HDMI  
721007 1 ext, net, VGA, audio, HDMI, USB  
721008 2 ext, 2 net, 2 USB charge

### Bi-Box Large

Exterior dimensions L. 605 W. 150 D. 118  
721001 silver -1 white -2 black

### Power Inlay for Bi-Box Large

721002 3 ext, 2 net  
721003 2 ext, net, VGA, audio, HDMI  
721007 1 ext, net, VGA, audio, HDMI, USB  
721008 2 ext, 2 net, 2 USB charge  
721004 4 ext, 4 net, 4 USB  
721005 4 ext, net, VGA, audio, HDMI  
721006 4 ext, 4 net, VGA, audio, HDMI, USB  
721009 5 ext, net, HDMI, 4 USB charge

For more information about Bi-Box and Power Inlay, see page 138.

### Quick Cable holder

687548-2	L. 480 W. 120 D. 80	black
687548-3	L. 480 W. 120 D. 80	silver
687573-2	L. 730 W. 120 D. 80	black
687573-3	L. 730 W. 120 D. 80	silver

### G-49 and G-79 Cable holder

621080-2	L. 490 W. 95 D. 85	black
621080-3	L. 490 W. 95 D. 85	silver
621081-2	L. 790 W. 95 D. 85	black
621081-3	L. 790 W. 95 D. 85	silver

### CableCare holder value pack

2 cable holders, 4 mounting ladders, installation kit.

700150-2	L. 490 W. 105 D. 145	black
700150-3	L. 490 W. 105 D. 145	silver
700180-2	L. 790 W. 105 D. 145	black
700180-3	L. 790 W. 105 D. 145	silver

### SUPPLEMENTS:

#### CableCare Cable holder

700250-2	L. 490 W. 105 D. 145	black
700250-3	L. 490 W. 105 D. 145	silver
700280-2	L. 790 W. 105 D. 145	black
700280-3	L. 790 W. 105 D. 145	silver

#### Mounting ladder

700237-2	L. 360/85 W. 45	black
700237-3	L. 360/85 W. 45	silver

### Cable holder for Conference table

Cable holder adapted for the Power Box. With foldable ends for optimum suitability. Made from sheet-metal. Please see page 61 for Complete set. Width bottom: 130 mm. Top 270 mm.

720000-1	L. 660 W. 130-270 D. 141	white
720000-2	L. 660 W. 130-270 D. 141	black
720000-3	L. 660 W. 130-270 D. 141	silver
720010-1	L. 290 W. 130-270 D. 141	white
720010-2	L. 290 W. 130-270 D. 141	black
720010-3	L. 290 W. 130-270 D. 141	silver



## POWER GROMMET TWIST

With bayonet for easier mounting. A user friendly power extension with four cable guides, comes in brushed aluminum frame. Quick and easy to install in an 80 mm diameter circular hole.



## CABLE GROMMETS

We have a wide range of cable grommets. For all models, see [www.gotessons.com](http://www.gotessons.com).



## ALUMINUM COVER

With brush guard. Available in three different sizes.



## CABLE COLLECTOR

Collects cables from desk to floor, wall or ceiling. Flexible plastic construction.



## CABLE COLLECTOR IN FABRIC WITH ZIP



## CABLE COLLECTOR PET



## CABLE COLLECTOR Ø 22

Flexible plastic collector for cables, to be opened and closed with a simple tool.

## CABLE GROOMETS/COLLECTORS

Art.No	Size/Description <i>(all dimensions in mm)</i>	Colour
--------	---	--------

**Power Grommet Twist Ø 80 mm**  
700532 1 extension 1,5 m. cable black/silver



For all models and more information, see page 144.



**Cable grommet plastic Ø 60 mm**  
700303-1 white -2 black -3 silver



**Cable grommet zinc Ø 63 mm**  
700293 mat chrome 700294 chrome



**Cable grommet plastic Ø 79 mm**  
700288-1 white -2 black -3 silver



**Cable grommet chrome plastic Ø 79 mm**  
700291 chrome



**Cable grommet with brush Ø 79 mm**  
700295 silver -2 black



**Cable grommet zinc Ø 80 mm**  
700301 chrome -1 nickel -2 mat chrome -4 white



**Cable grommet zinc oval Ø 80 mm**  
700302 chrome -1 nickel -2 mat chrome



### Circular saw

699200	Ø 64 mm
699300	Ø 79 mm
699400	Ø 80 mm



### Aluminium cover

Table cut out: 80x80=70x70, 150x80=141x70, 270x80=261x70

695340	80 x 80	silver
695340-1	80 x 80	white
695342	150 x 80	silver
695342-1	150 x 80	white
695343	270 x 80	silver
695343-1	270 x 80	white



### Cable collector in fabric with zip

110089	L. 1,5 m, black fabric, black zip
110090	L. 1,5 m, white fabric, white zip
110081	L. 3 m, black fabric, black zip
110083	L. 3 m, white fabric, white zip



### Cable collector PET

110073	L. 25 m	white
110074	L. 25 m	black
110075	L. 25 m	silver
110085 white	110086 black	110087 silver



### Cable Collector Ø 65

107558-2	L. 780 (15 sections) Ø 65	black
107558-3	L. 780 (15 sections) Ø 65	silver
107559-2	L.1230 (24 sections) Ø 65	black
107559-3	L.1230 (24 sections) Ø 65	silver
107560-2	Single section	black
107560-3	Single section	silver



### Cable Collector Ø 22

Facts: The flexible tube can simply be opened and closed to add cables very easily. Collects cables between wall socket and desk.

110050	Inner dimension Ø 22	black
110051	Inner dimension Ø 22	silver
110052	Inner dimension Ø 22	white



### Tool for cable collector Ø 22

110055	Ø 22
--------	------



### Cable Collector Ø 22 value pack

2,5 m cable collector Ø 22 + tool. 110060 silver



### Cable Collector Ø 14 Mini

110061	Inner dimension Ø 14	black
--------	----------------------	-------

### Tool for cable collector Ø 14 Mini

110065	Ø 14
--------	------



# WE WORK TOGETHER!

## AM ACOUSTICS & Gotessons

One of the great news this year is that we welcome nine acoustic products from our affiliate company AM Acoustics, which now will be included in our product range. The same acoustic benefits and the same excellent quality, but under the flag of Gotesson. We are very happy about that! We have tagged the products with the label "by AM Acoustics" to help you find the products in the catalogue and on the web. On the image to the right you see new product *Effekt* a very efficient sound absorber and room divider. Make the product unique by combining your choice of textile, core material and colour on the hang wires.



## DESIGN your products online

In association with pCon planner, we have composed a digital design tool for our textile products on the web. This allows you to design a product with colour, zipper and seam of your choice and download these in a variety of image and drawing formats. You can also use your own designed products in your drawing program with other interior design objects. You can find all Gotessons range of products in pCon planner, such as plants, monitor arms, soft seatings, desk and floor screens, and the popular *The Hut Collection*. Welcome to design your own products on gotessons.com.

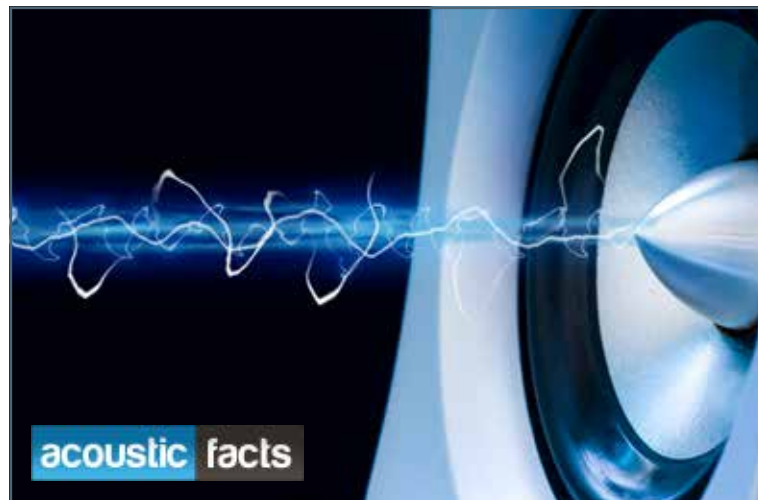

## A BETTER looking sound

Together with AM Acoustic, we have accumulated an understanding and knowledge about acoustics over the years. Partly through all the projects we are involved in, but also through close and frequent collaborations with acousticians and interior designers. As we develop our products and acoustic solutions, there are, in addition to the acoustic aspect, environmental focus, form and format flexibility as well as the ability to integrate and strengthen other interior design, which are important factors for creating "A Better Looking Sound." We test all our products according to Swedish Standard SS 25269.

## BIGPRINT a maximized sound absorber

If there is a need for a bigger sound absorbing print, our colleagues in Falkenberg will help you with this. They are professionals and pioneers in Sweden to produce large printed absorbents according to customer needs and design.

Bigprint is a sound absorber that lends itself to be the centerpiece of your design. Decide upon graphics using a photo/illustration of your own, or purchase a photo from an artist of your choice. Bigprint come in sizes of up to 50 x 5 metres without having to cut the canvas, something that has been requested by many interior designers.

- Produced with AM Acoustics' EcoSUND core material.
- No cutting of the canvas or seam.
- You decide the format and size.
- Can be delivered in super large sizes but works fine in smaller sizes too. ( We deliver Bigprint in small packages)
- If you want to change the image/canvas in the future, only new printed fabrics need to be purchased. The aluminum frame and Ecosund sound absorbers remain intact.



# WE WORK TOGETHER!





# ELECTRICAL ACCESSORIES

Vibrant business rooms, quiet IT rooms, creative rooms, hotel rooms or conference rooms, regardless of the environment, we offer the appropriate solution for much needed downloading, access connections or recharging. Regardless of connections and technologies, we solve your needs.





## BI-BOX / BI-LID

Bi-Box is a lateral openable lid and cable box in one. The lid can easily be opened in both directions. Soft close function. Add separate Power Inlay. See video at [www.gotessons.com](http://www.gotessons.com). Bi-Box is available in two sizes. The table cut out hole are the same as Gotessons original Power Box single/double.

Bi-Lid is only with an openable lid.

For more information about cable length etc, see [www.gotessons.com](http://www.gotessons.com). For French/Polish sockets add -FR behind art.no. For UK sockets add -UK behind art.no. For Danish sockets add -DK behind art.no.

## GST18

GST18 junction box with quick release connectors for a simple connection of several junction boxes. Suits ex. Bi-Boxes. Max 16A.

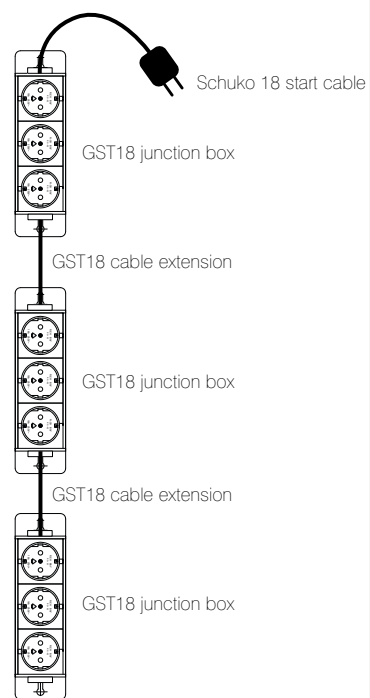

## BI-BOX/GST18

Art.No	Size/Description <i>(all dimensions in mm)</i>	Colour
--------	---	--------

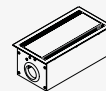

### Bi-Box Small

Bi lateral openable lid and cable box in one.  
L.300 W.150 D.118. Table cut out 286x135 mm.  
721000 silver -1 white -2 black

### Power Inlay for Bi-Box Small and Large

Easy to mount with screws, in to the bottom of the Bi-Box.  
Suitable in Bi-Box Small and Large.

721002	3 ext, 2 net	
--------	--------------	--

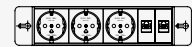

721003	2 ext, net, VGA, audio, HDMI	
--------	------------------------------	--

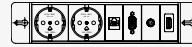

721007	1 ext, net, VGA, audio, HDMI, USB	
--------	-----------------------------------	--



721008	2 ext, 2 net, USB charge	
--------	--------------------------	--

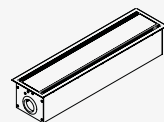

### Bi-Box Large

Bi lateral openable lid and cable box in one.  
L. 605 W. 150 D. 118. Table cut out 592x135 mm.  
721001 silver -1 white -2 black

### Power Inlay for Bi-Box Large

Easy to mount with screws, in to the bottom of the Bi-Box.  
Only suitable in Bi-Box Large.

721004	4 ext, 4 net, 4 USB	
--------	---------------------	--

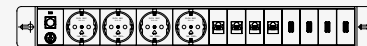

721005	4 ext, net, VGA, audio, HDMI	
--------	------------------------------	--

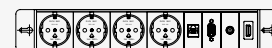

721006	4 ext, 4 net, VGA, audio, HDMI, USB	
--------	-------------------------------------	--

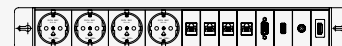

721009	5 ext, net, HDMI, 4 USB charge	
--------	--------------------------------	--



### JUNCTION BOX GST18

Junction box with GST18 connector for series connection.

721803	3 extension	
--------	-------------	--



721806	6 extension	
--------	-------------	--



### CABLE GST18

#### GST18 start cable

To connect GST18 junction box with socket.

721804	L. 3 m, Schuko-GST18 male
721805	L. 5 m, Schuko-GST18 male

#### GST18 cable extension

To connect GST18 junction box with each other.

721807	L. 1 m, GST18 female-GST18 male
721808	L. 3 m, GST18 female-GST18 male

#### Desk mount for Power Inlay

To mount Power Inlay in desk top or in a existing hole.

697502	black
--------	-------

#### Bi-Lid Small

Bi lateral openable lid. L. 300 W. 150 D. 42.

Table cut out 286x135 mm.

721200	silver -1 white -2 black
--------	--------------------------

#### Bi-Lid Large

Bi lateral openable lid. L. 605 W. 150 D. 42.

Table cut out 592x135 mm.

721201	silver -1 white -2 black
--------	--------------------------

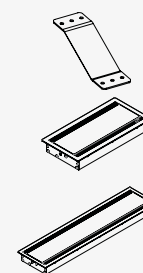
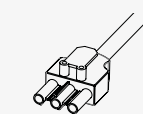

Art.No. 721003.

## BI-BOX

Connect several of Bi-Boxes in a conference table with GST18 junction boxes.

## POWER INLAY

All Power Inlay delivered with short cables. See page 138 for cable extension.



## TABLE TOP

For easy access of extensions the Table Top is available in different outlets and colours. Can also be installed in walls, cabinets, headboards etc.



## TABLE TOP

Art.No	Size/Description <i>(all dimensions in mm)</i>	Colour
--------	---	--------

### Table Top

3 m extension cable included. No other cables included. Can be ordered with other sockets. Max desk thickness 50 mm. Depth 83 mm.

691029 silver -1 white -2 black  
2 ext. Table cut out, 192x73 mm.

691126 silver -1 white -2 black  
1 ext. 2 USB charge Table cut out, 131x73 mm.

691027 silver -1 white -2 black  
3 ext. Table cut out, 242x73 mm.

691028 silver -1 white -2 black  
2 ext, 2 net, USB charge, VGA, HDMI, audio. Table cut out, 263x73 mm.

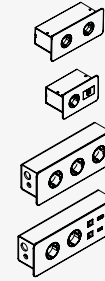

### Mounting kit for vertical mounting of Table Top

For mounting on wall or cupboard.  
691023-2

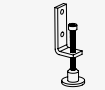

### Table Top with hole for The Lightning

Table Top with a hole suitable for The Lightning, info on page 106-107. 3 m extension cable included. No other cables included. Can be ordered with other sockets. Max desk thickness 50 mm. Depth 83 mm. 1 ext, 2 USB charge.

Table cut out: 131x73 mm and drilled hole Ø25 mm.

821061-1 white  
821061-2 black



### The Lightning desk lamp

Can be mounted on the desk or in a Table Top with hole for a lamp.  
Drilled hole Ø25 mm.

821055-1 See drawing on page 106 white  
821055-2 See drawing on page 106 black







## POWER BOX SINGLE

Developed for discreetly supplying desks and conference tables with power sockets, network. Ideal for working with laptop. Female sockets.



## POWER BOX EXTRA LONG

Power Box extra long with 3 extensions, 1 network, 2 USB, VGA, HDMI and audio.

## POWER BOX SINGLE

Art.No Size/Description  
(all dimensions in mm) Colour

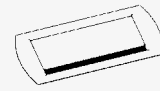

### Power Box Unarmed

Table cut out, 286x135 mm.

691010 silver  
691010-1 white

### Power Box 3 ext, 2 net\*

691000 silver  
691000-1 white

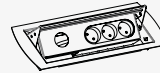

### Power Box 3 ext. hole for retractable cables

691070 silver  
691070-1 white



### Power Box 3 ext, 2 net, VGA, audio

691035 silver  
691035-1 white



### Power Box 3 ext, net, VGA, HDMI, audio

691037 silver  
691037-1 white

Power Box are delivered with 1,5 m electricity cable. Standard CE schuko sockets. For French sockets, same price, just add -FR after article number. For UK and other sockets, contact us.

### Cable holder Power Box Single

Cable holder adapted for the Power Box Single, with foldable ends for optimum suitability. Made from sheet-metal. Width bottom: 130 mm. Top 270 mm.



720010-1 L. 290 W. 130-270 H. 141 white  
720010-2 L. 290 W. 130-270 H. 141 black  
720010-3 L. 290 W. 130-270 H. 141 silver

### Power Box unarmed extra long

L. 432 W. 170. Table cut out, 367x135 mm.

691710 silver  
691710-1 white

Tip. Use with Complete Set. See page 131.

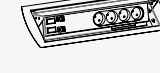

### 4 extensions, 2 network Cat.6.\*

691700 silver  
691700-1 white

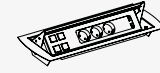

### 3 extensions, 2 USB

691750 silver  
691750-1 white

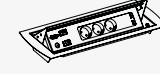

### 3 extensions, 1 network, 2 USB, VGA, HDMI, audio

691760 silver  
691760-1 white

Only available in CE schuko.

\*Mounted network connections Cat.6 and earthed extensions. Possible to add 2 extra network connections. See page 143.

Tip!

Complete Power Box with:

- Cable holder
- Cable collector
- G-clips



## POWER BOX DOUBLE

Developed for working with laptop in a conference environment. Lids can be opened in two directions, see picture with cross opening.



## CABLE HOLDER FOR CONFERENCE TABLES

Cable holder adapted for the Power Box Double.

## POWER BOX DOUBLE

Art.No Size/Description  
(all dimensions in mm) Colour

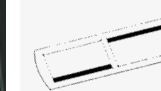

### Power Box Unarmed

Table cut out, 592x135 mm.

691610 silver  
691610-1 white

### Power Box 6 ext, 4 net\*

691600 silver  
691600-1 white

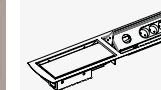

### Power Box 6 ext, hole retractable cables

691670 silver  
691670-1 white



### Power Box 6 ext, 4 net\*\*, VGA, audio

691635 silver  
691635-1 white

Power Box is delivered with 1,5 m electricity cable. Standard CE schuko sockets. For French sockets, same price, just add -FR after article number. For UK and other sockets, contact us.

### Cable holder for Conference tables

Cable holder adapted for Power Box Double, foldable ends for optimum suitability. Made from sheet-metal. Width bottom: 130 mm. Top 270 mm.



720000-1 L. 660 W. 130-270 H. 141 white  
720000-2 L. 660 W. 130-270 H. 141 black  
720000-3 L. 660 W. 130-270 H. 141 silver

### Network switch (CE schuko)

700580 5 ports, 10/100 Mbps. Exterior dimension: 148x28x87 mm. Can be placed in a cable holder for conf.table.  
700587 16 ports, 10/100 Mbps. Exterior dimension: 200x40x142 mm. Can be placed in a cable holder for conf.table.



### Video-switch (VGA)

Plug in up to 8 computers to one monitor/LCD/projector. Switch with remote control. Max resolution 2048x1536. Place in conference cable holder. CE schuko. 700588



### Plastic clip for cables: VGA, network, audio etc.

700567

### Extra network connections \*\*/\*\*

Network conn. Cat.6 for punched holes. Suits also as an extension of network cables (female-female). 700581 black

### Extra network connections Cat. 6 & 7 shielded

Shielded network conn. Cat.6 and 7 for punched holes. Cable length 2 m.

700598 Cat. 6 shielded  
700599 Cat. 7 shielded

### Extra HDMI module

For punched holes in the Power Box. 700607

\*Mounted network connections Cat.6 and earthed extensions. Possible to add 4 extra network connections.

\*\*Mounted network connections Cat.6 and earthed extensions. Possible to add 2 extra network connections.







## G-POWER QI WIRELESS CHARGER FOR MOBILES

Wireless charger for mobile phones compatible with Qi standard. Charging cover for mobile phones without this feature are available on the market. USB cable included for mobile. Mounted in hole of Ø 80 mm.



## POWER GROMMET TWIST

With bayonet for easier mounting. A user friendly power extension with cable guides. Quick and easy to install in an 80 mm diameter circular hole.

## G-POWER AND POWER GROMMET

Art.No	Size/Description <i>(all dimensions in mm)</i>	Colour
--------	---	--------



### G-Power Qi Wireless Charger for mobile

Wireless charger for mounting in hole of Ø 80 mm. USB cable included.

721333		black
--------	--	-------

### Power adapter for G-Power Qi

Adapter for wall sockets.

721334		white
--------	--	-------

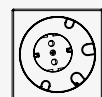

### Power Grommet Twist Ø 80 mm

Fits in any Ø 80 mm grommet hole. An aluminium brushed grommet with socket, 1,5 m. cable and 4 cable guides.

700532	1 extension, 4 cable holes	black/silver
700532-1	1 extension, 4 cable holes	black/white
700532-2	1 extension, 4 cable holes	black/black

700539	1 FR extension, 4 cable holes	black/silver
700539-1	1 FR extension, 4 cable holes	black/white
700539-2	1 FR extension, 4 cable holes	black/black

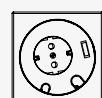

### Power Grommet Twist USB charge Ø 80 mm

702532	1 ext, 1 USB, 2 cable holes	black/silver
702532-1	1 ext, 1 USB, 2 cable holes	black/white
702532-2	1 ext, 1 USB, 2 cable holes	black/black
702539	1 FR ext, 1 USB, 2 cable holes	black/silver
702539-1	1 FR ext, 1 USB, 2 cable holes	black/white
702539-2	1 FR ext, 1 USB, 2 cable holes	black/black



### Power Grommet Twist round Ø 80 mm

703532	1 extension, 4 cable holes	black/silver
703532-1	1 extension, 4 cable holes	black/white
703532-2	1 extension, 4 cable holes	black/black
703539	1 FR extension, 4 cable holes	black/silver
703539-1	1 FR extension, 4 cable holes	black/white
703539-2	1 FR extension, 4 cable holes	black/black



### Power Grommet Twist round USB charge Ø 80 mm

704532	1 ext, 1 USB, 2 cable holes	black/silver
704532-1	1 ext, 1 USB, 2 cable holes	black/white
704532-2	1 ext, 1 USB, 2 cable holes	black/black
704539	1 FR ext, 1 USB, 2 cable holes	black/silver
704539-1	1 FR ext, 1 USB, 2 cable holes	black/white
704539-2	1 FR ext, 1 USB, 2 cable holes	black/black

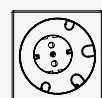

### Power Grommet GST 18 Ø 80 mm

Fits in any Ø 80 mm grommet hole. GST 18 connection. Cable length: 1,5 m. Cable thickness: 2,5 mm.

700332	1 extension, 4 cable holes	black/silver
--------	----------------------------	--------------



### USB GROMMET

#### USB Grommet for charging, Ø 60 mm

Fits in Ø 60 mm grommet hole. Cable length: 1,5 m.

705532	2 USB	black/silver
705532-1	2 USB	black/white
705532-2	2 USB	black/black



Tip!  
See product videos at  
[www.gotessons.com](http://www.gotessons.com)

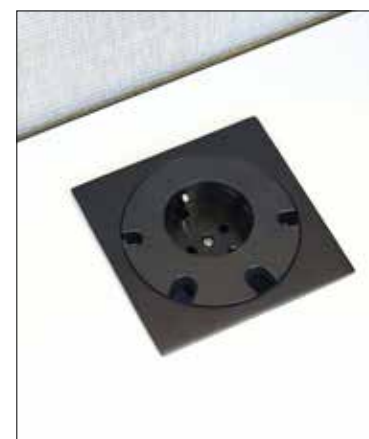

Power Grommet Twist  
Ø 80 mm. Black/black.



Power Grommet Twist Round  
Ø 80 mm. Black/silver.



Power Grommet Twist USB Round  
Ø 80 mm. Black/white.



USB Grommet for charging  
Ø 60 mm. Black/white.



Tip!  
Power clamp is available in several extensions types for different countries.



**OFFICE POWER CLAMP**  
A user friendly anodized aluminum frame with standard three sockets, two network connections including desk clamp and a 2,88 m electrical cable included.

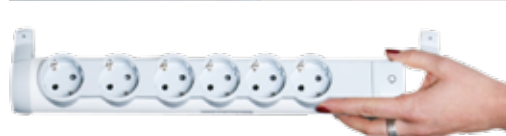

**TURNABLE JUNCTION BOX**  
Can easily be mounted on or under the desk or in the Gotessons cable holder for conferences. Adjustable 360°. Protects against electrical overload and risk of overheating. Also available with desk clamp.

**OFFICE POWER CLAMP**

Art.No	Size/Description <i>(all dimensions in mm)</i>	Colour
--------	---	--------

**Office Power Clamp**

Extruded aluminum profile, can be used in various ways. Can be ordered with English and French/Polish sockets. Clamp and 2,88 m cable included.

	697038 2 schuko sockets	silver
	697040 2 FR sockets	silver
	697041 2 UK sockets	silver
	W. 147 H. 78 D. 91	
	697030 3 schuko sockets, 2 net	silver
	697032 3 FR sockets, 2 net	silver
	697033 3 UK sockets, 2 net	silver
	W. 225 H. 78 D. 91	
	697047 4 schuko sockets, 4 net, VGA, HDMI, audio	silver
	W. 400 H. 78 D. 91	
	697048 3 schuko sockets, one hole for retractable cable	silver
	W. 237 H. 78 D. 91	
	697049 2 schuko sockets, 2 USB	silver
	W. 176 H. 78 D. 91	
	697042 2 schuko sockets, 1 net, 2 USB	silver
	W. 270 H. 78 D. 91	

**Turnable extensions**  
Fixed with screw under or above desktop.  
Length: 4 way 290 mm, 6 way 380 mm.

	700420 4-way earthed, 3 m cable	white/grey
	700421 6-way earthed, 3 m cable	white/grey

**Turnable junction box with desk clamp**  
Desktop thickness max 50 mm.  
Length: 4 way 290 mm, 6 way 380 mm.

	700424 4-way earthed, 3 m cable	white/grey
	700425 6-way earthed, 3 m cable	white/grey



**WORD LIST**

- VGA**  
Analogue connection between monitor and CPU.
- Mini-jack 3,5 mm**  
Analogue audio connection. For adding audio to presentations or for headset use.
- HDMI**  
Audio - visual digital connection between monitor and CPU. An audio-visual connection to the main monitor.
- Displayport**  
Audio - visual digital connection between monitor and CPU. Commonly used on Mac.
- USB**  
To transfer data. Connect memory sticks for office presentations, camera memory card readers, GPS, printers or synchronized mp3/mobile.
- Network**  
Internet access.
- GST 18**  
Contact us for other specifications. Can be ordered in different lengths and combinations male/female.
- Network switch**  
Splits one incoming network connection into 5 or 16 useable connections.
- VGA switch**  
To connect several CPU to one projector or main monitor. Switch from one CPU to another via remote control.

**PRODUCT INFORMATION**

Art.No	Size/Description <i>(all dimensions in mm)</i>	Colour
--------	---	--------

- Monitor cable (VGA)**

	700550 L. 2 m male-female cable extension	
	700551 L. 3 m male-female cable extension	
	700584 L. 1 m male-male	
	700578 L. 2 m male-male	
	700566 L. 5 m male-male	
	700577 L. 15 m male-male	
- Audio cable (for mini-jack)**

	700572 L. 5 m male-female cable extension	
	700595 L. 2 m male-male	
	700596 L. 5 m male-male	
- HDMI cable**

	700591 L. 2 m male-male	
	700592 L. 5 m male-male	
- Displayport**

	700614 L. 3 m male-male	
--	-------------------------	--
- Network cable STP Cat.6 Shielded**

	700575 L. 1 m	
	700564 L. 3 m	
	700559 L. 5 m	
	700571 L. 7 m	
	700568 L. 10 m	
- GST18 start cable**  
To connect GST18 junction box with socket.
 

	721804 L. 3 m, Schucko-GST18 male	
	721805 L. 5 m, Schucko-GST18 male	
- GST18 cable extensions**  
To connect GST18 junction box with each other.
 

	721807 L. 1 m, GST18 female-GST18 male	
	721808 L. 3 m, GST18 female-GST18 male	
- Extension earthed/grounded**

	700600 L. 6 m	white
	701000 L. 10 m	white
- Network switch (CE schuko)**

	700580 5 ports, 10/100 Mbps. Exterior dimension: 148x28x87 mm. Can be placed in a cable holder for conf.table.	
	700587 16 ports, 10/100 Mbps. Exterior dimension: 200x40x142 mm. Can be placed in a cable holder for conf.table.	
- Video-switch (VGA)**  
Plug in up to 8 computers to one monitor/LCD/projector. Switch with remote control. Max resolution 2048x1536. Place in conference cable holder. CE schuko.
 

	700588 W. 200 H. 40	
--	---------------------	--
- FABRIC COVERED CABLES**
- HDMI cable**

	700610 L. 1,5 m	black
	700611 L. 1,5 m	red
- VGA cable**

	700612 L. 1,5 m	black
	700613 L. 1,5 m	red
- Adapter displayport to VGA**  
700641
- Adapter displayport mini to VGA**  
700642



## STARTING FROM SCRATCH ...

Ola Götesson developed the world's first cable tray in 1992. It was and still is an important part of Gotessons history. A lot of new products have been developed over the years but the basic idea is still the same, an optimally functioning workplace.

Our strength is that we now have a large product range with coordinating design to fit optimally with each other for a functional and attractive workplace.

The pictures speak for themselves, also see product videos at [www.gotessons.com](http://www.gotessons.com).





# GOTESSONS 2018

For pictures, drawings, movies and other information, see [www.gotessons.com](http://www.gotessons.com).

## GENERAL INFORMATION

**Terms of delivery:** According to agreement.

**Deliverytime:**

- L 2-5 days** In stock, dispatch 2 - 5 days
- B 5-10 days** Delivery 5 - 10 days
- B 4-6 weeks** Delivery 4 - 6 weeks

For larger orders or special delivery, information will be sent separately. We reserve the right of longer delivery times for some products.

**Terms of payment:** According to agreement. Excl. VAT. We reserve the right to adjust prices.

**Delivery:** According to agreement (immediate delivery where possible). Damages during transport: If the packaging arrives damaged, report directly to the transport company and note this on the delivery sheet when signing. We reserve the right to deny damage claims if this is not done.

**Claims:** Any claims should be made to Gotessons within 7 days from reception of goods, including proof of picture. Gotessons must approve returns in advance. Returns due to mistakes in the order caused by customer will be credited by 80% of the value of the invoiced product. Products must be returned in the original packaging. Freight costs will be paid by the customer. Please note, this does not apply to special or screens, no returns can be accepted.

**Guarantee:** 2 years. (Apply to seats with recommended fabrics.)



QUALITY ISO 9001:2000  
ENVIRONMENT ISO 14001:200

Our policy is to continuously improve our products and performance. The environment is an integral part of all our business operations, we aim to be sustainable in all meanings of the word.

### acoustic facts

Swedish standard approved SS 25269. See [acousticfacts.com](http://acousticfacts.com)



Gotessons products are also available on:-



pCon.planner is a professional and free 3D design software. You'll be able to create complex projects in a very simple way. No matter if you are an interior designer, a facility manager or a retailer you'll find in pCon.planner an innovative and powerful work tool. See [pcon-planner.com](http://pcon-planner.com)

© Copyright. Products from Gotessons Industri AB in Dalstorp, Sweden. [www.gotessons.com](http://www.gotessons.com)



# PRODUCT INDEX A-Z

**Delivery time:**

- L 2-5 days** In stock, dispatch 2 - 5 days
- B 5-10 days** Delivery 5 - 10 days
- B 4-6 weeks** Delivery 4 - 6 weeks

L A4 shelf for screens.....	39	L Floor protection.....	98	L Power Box Single.....	142
L A4-tray plexi for screens.....	39	B Floor screen Block.....	46	L Power Grommet.....	133, 144
L Adapter Displayport.....	147	B Floor screen ScreenIT A30/plexi.....	42, 43	L Power Inlay.....	132, 138
L Anyway CPU holder.....	128	B Floor screen ScreenIT A30 booth.....	50, 51	L Power shelf for toolbar.....	38
L Armrest.....	98	B Floor screen ScreenIT A30 Flexible.....	18	L Power shelf with clamp.....	126
L Assembly hook for Halfpipe.....	131	B Floor screen A30 The Rising.....	44, 45	L Quick Cable holder.....	132
L Audio cable.....	147	B Floor screen A30 Tower Booth.....	47	B Replacement filter for PAZ.....	25,93
L Bi-Box.....	132, 138	B Floor screen Peak Design Booth.....	48, 49	L SetUpit recycling.....	122-123
L Bi-Lid.....	138	B Floor screen ScreenIT A30/A40.....	43	L SetUpit with pull-out pen drawer.....	122
L Binder shelf.....	38	B FoldIT/FoldIT Basic.....	23	L Silent Pendant Lamp.....	110, 111
B BoxUp.....	129	L Foot support.....	98	L Simple Rest.....	98
B BringIT.....	124	L Freewall.....	34	L Slim TV-mount.....	119
L Bubble - mat.....	97	L G-49 & G-79 cable holder.....	132	B SMS-Box.....	90
L Cable Care Cable holder.....	132	B G-box.....	129	B Sofa Silent Group.....	59
L Cable Collector.....	133	L G-clips.....	131	B Sofa Sound Booth.....	92
L Cable holder for conf. table.....	132, 142-143	L G-Power Qi.....	144	B Sound Off ceiling acoustics.....	72-74
L Cable Grommets.....	133	L GST 18 connection.....	147	B Sound Off letters.....	69
B Ceiling acoustics Effekt.....	52, 53, 76	L Halfpipe adjustable.....	130	B Sound Off wall acoustics.....	71
B Ceiling acoustics Nivå.....	79	L Halfpipe cable holder.....	130	L Stand CPU holder.....	128
L Circle saw for cable grommet.....	133	L Halfpipe Complete.....	131	L SwingIT CPU holder.....	128
L Client box.....	128	L Halfpipe Plastic end.....	131	L Table Top.....	140
L Complete set.....	131	L Hand.....	36	L Tarifold holder.....	36
B Connecting Seat.....	91	B Hang On.....	90	L Telephone holder.....	118
L CPU holder 1.....	128	L HDMI cable.....	143, 147	B The Hut Collection.....	54-58
L CPU holder with lockable tray.....	124	L Hook for ScreenIT A30.....	39	B The Hut Roof.....	79
B Cushions.....	92	L Junction box.....	131	L The Lightning.....	106, 107, 140
L D-Zine arm double.....	118	L Keyboard holder.....	119	L Tulip/Tulip Toolbar.....	36, 108, 109
L D-Zine arm singel.....	116	L Laptop Box.....	126	L Turnable extensions.....	145
L D-Zine arm Toolbar.....	37	L Laptop lockable draw.....	126	L Toolbar accessories.....	36-39
L D-Zine arm Wall/Wallbracket.....	119	L Laptop holder for toolbar.....	38	L TwistIT.....	125
B Desk screen PAZ (Pure Air Zone).....	24-25	L Laptop shelf for monitor arm... 36,37,116,118		L V3 Single arm.....	117, 118
B Desk screen ScreenIT A30.....	14-15	L Linjë 4Way Toolbar.....	35	L V3 Twin arm.....	118
B Desk screen ScreenIT A30 K.....	14, 19	L Magnet memo board with holder.....	38	L VESA adapter plate.....	116, 117,119
B Desk screen ScreenIT A30 P1.....	14, 19	L Metal plate for reversed desk edge.. 116,117		L VGA cable.....	147
B Desk screen ScreenIT A30/A40 with rail....	20	L Mounts.....	32-33	L VGA switch.....	143, 147
B Desk screen ScreenIT A30 above desk....	22	L Multitray.....	38	B Wall acoustics A30.....	70
B Desk screen ScreenIT A30 All In One.....	21	L Name tag for screens.....	39	B Wall/Notice board Collage.....	65
B Desk screen ScreenIT A30 booth.....	22	L Network cable.....	147	B Wall acoustics Honey.....	80
B Desk screen ScreenIT A30 Flexible.....	18	L Network connections.....	143	B Wall acoustics Nivå.....	78
B Desk screen ScreenIT A30 Reinforced.....	19	L Network switch.....	143, 147	B Wall/Notice board Storyboard.....	64, 81
B Desk screen ScreenIT A30 Sidescreen.....	23	B Office Ballz.....	86,87	B Wall acoustics Tell-Us.....	68
B Desk screen ScreenIT A30 Slide.....	17	B Office Nap.....	88, 89	B Wall and ceiling acoustics Hang Over.....	75
B Desk screen ScreenIT A30 with plexi.....	28	L Office Power Clamp.....	146	B Whiteboard Floor Screen.....	39
B Desk screen ScreenIT A40/Reinforced.....	26	L Pen drawer/Lockable draw.....	126	L Whiteboard for screens.....	39
B Desk screen ScreenIT AT40/above desk..	27	L Pen tray Halfmoon.....	127	L Whiteboard/Memoboard.....	62, 63
B Desk screen ScreenIT AT40/with rail.....	20	L Pen holder for toolbar.....	36	Wordlist.....	147
B Desk screen ScreenIT Plexi.....	29	L Pen tray for screens.....	39	L Yoga mat.....	96
B Desk screen ScreenIT Standard.....	16	B PAZ Sofa.....	93	L ZAP arm Twin.....	114, 118
L Displayport.....	147	L Plants.....	102-103	L ZAP arm Single.....	114
L DockIT.....	124	L Plant pots/Oil drums.....	102	L ZAP arm Toolbar 3.....	37
L DockIT Design.....	124	L Plastic bags for SetUpit.....	123		
L Double bracket.....	118	L Plastic folder for tarifold.....	36		
L File holder.....	38	B Plexitop for screens.....	39		
L Floor cable collector aluminium.....	127	L Post tray.....	38		
L Floor collector TPE.....	127	L Power Box Double.....	143		





## GOTESSONS

Gotessons with a new head office and distribution center in Ulricehamn, develops and markets products for office, conference, restaurant and hotel workspaces. We offer ergonomic, functional and well designed turnkey solutions to more than 40 countries using our motto "From Workplace to Creative Space".

**Visit us at [gotessons.com](https://www.gotessons.com)**