

These measurements refer to the frame work and do not include upholstery, seam or zip

Tolerances (mm)			
Dimension			Deviation
(1)	-	20	±0,2
(20)	-	50	±0,5
(50)	-	200	±1,0
(200)	-		±2,0

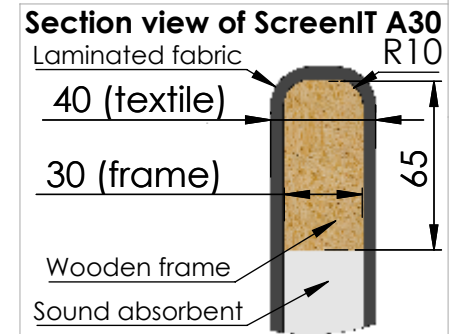
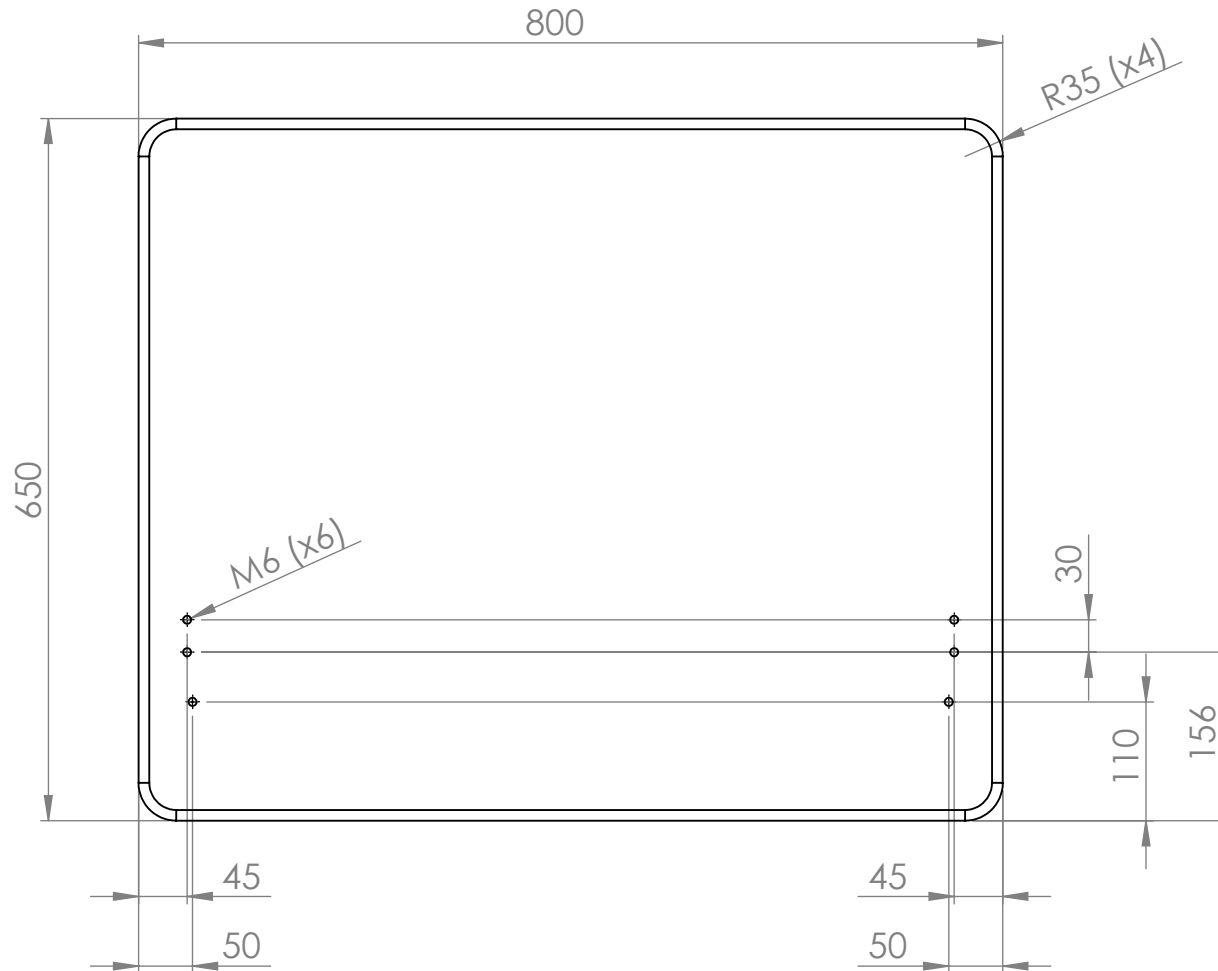

Material	x	Art.nr.	648080	Blad	1/1	A4
Skala	1:7	Sign.	Tolle	Benämning	Reinforced ScreenIT A30 800x650	
		Datum	2017-08-25			Rev
						-